

INSTRUCTION MANUAL FT-720R SERIES



FOX TANGO INTERNATIONAL

YAESU MUSEN CO., LTD.

TOKYO, JAPAN

YAESU FT-720R SERIES VHF/UHF FM TRANSCEIVER

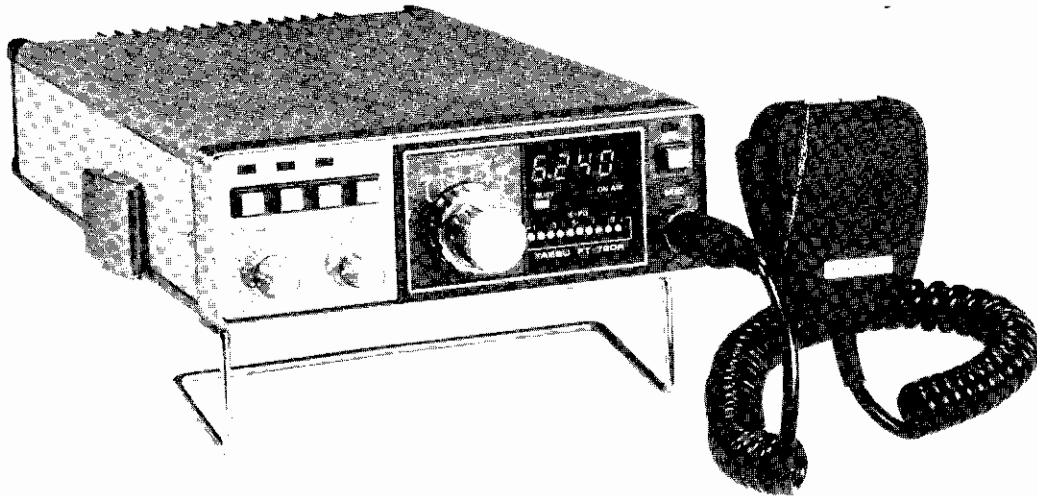

INTRODUCTION

The FT-720R is a compact line of VHF and UHF FM mobile transceivers. Fully PLL synthesized in 10 kHz or 12.5 kHz steps (depending on your locality), the FT-720R includes a control head with all operating controls, plus RF decks for either 2 meter or 70 cm operation. An optional switching box is available, allowing you to switch between the 2 meter and 70 cm RF decks.

A four bit microprocessor is used for all frequency control, providing unmatched flexibility in your operating. Four channels of frequency memory, plus a "receive memory" channel for unusual repeater splits, are provided. You may also select a priority channel for watching your favorite repeater or simplex channel. Up/down scanning of both dial and memory channels is provided, with control for the microphone.

An optical coupling system is used for channel selection, thus eliminating noisy, unreliable rotary switches that are sometimes used in other radios. The microprocessor then translates the digital data from the photo-interrupter, controlling the operating frequency and digital display instantaneously.

We recommend that you read this manual in its entirety, so as to become better acquainted with your new FT-720R. With proper care in operation, this equipment will provide many years of satisfying operation.

SPECIFICATIONS

	FT-720RV	FT-720RU	
Frequency coverage:	144.00–147.99 MHz 144.00–145.99 MHz	430–439.975 MHz 440–449.975 MHz	
Synthesizer steps:	10 or 12.5 kHz	25 kHz	
Power output:	10 watts (RV model) 25 watts (RVH model)	10 watts	
Modulation type:	Variable reactance phase modulation	Variable reactance phase modulation	
Deviation (max):	±5 kHz	±12 kHz	
Maximum bandwidth	16 kHz	30 kHz	
Spurious emissions:	-60 dB or better	-60 dB or better	
Output impedance:	50 ohms	50 ohms	
Antenna connector:	SO-239	Type N	
Microphone impedance:	500–600 ohms	500 600 ohms	
Receiver type:	Double conversion superheterodyne	Double conversion superheterodyne	
First IF:	10.7 MHz	16.9 MHz	
Second IF:	455 kHz	455 kHz	
Sensitivity:	0.32 μ V for 20 dB quieting	0.5 μ V for 20 dB quieting	
Selectivity:	±6 kHz (-6 dB) ±12 kHz (-60 dB)	±12 kHz (-6 dB) ±24 kHz (-60 dB)	
Audio output:	1.5 watts @ 8 ohms @ 10% THD	1.5 watts @ 8 ohms @ 10% THD	
Audio output impedance:	8 ohms	8 ohms	
Power requirements:	13.8 VDC, negative ground 13.6 VDC (RVH model)	13.8 VDC, negative ground	
Current consumption:		Receive	Transmit
Case size:	FT-720RV FT-720RVH FT-720RU	0.5A 0.5A 0.5A	3.5A 6.5A 4A
Case size & weight:	FT-720R 720RV 720RVH 720RU	150(W) x 50(H) x 85(D) 150(W) x 50(H) x 161(D) 150(W) x 50(H) x 161(D) 150(W) x 50(H) x 161(D)	0.9kg Approx. 1.6kg Approx. 1.6kg Approx. 1.6kg Approx.

Specifications subject to change without notice.

SEMICONDUCTORS

	FT-720R	720RV	720RU		FT-720R	720RV	720RU
IC:				2SC945P	14	17	15
M57704M			1	2SC1674		1	1
M57715 (FT-720RV)		1		2SC1815GR	4	3	3
M57712 (FT-720RVH)		1		2SC2026		3	4
MC1496G		1	1	2SC2053		1	
MC14011B	2	1		2SC2407			2
MC14016B		1	1	2SD235Y	1	1	1
MC14519B	1			2SD892R	7		
MC14528B		1	1	MPS-A13	1		
MSL2311RS		1	1				
MSM5806RS		1	1	Diode:			
MSM5841-12RS	1			Germanium			
TA7612AP	1			1S188FM	2	6	5
TC5082P	1			Silicon			
μPC575C2	1			1S1555	18	15	14
μPC577H		1	1	1SS53		3	3
μPC78L05		1	1	10D1		1	1
μPC14305		1	1	U05B		1	1
μPC14308		1	1	Schottky barrier			
				1SS97			3
FET:				Varactor			
2SK19GR		1	1	1SV68		1	1
3SK48		1		1T25		1	1
3SK51-03		4	3	Zener			
3SK70			1	HZ-6-B2	1		
3SK76			1	LED			
				LN222RP	3		
Transistor:				LN422YP	7		
2SA496(O)		1	1	SG232D	1		
2SA719Q	5			SR632D	6		
2SC460B		2	2	LN543RA	1		
2SC535B		3	2	LN543RAH3	(1)	12.5kHz Model	

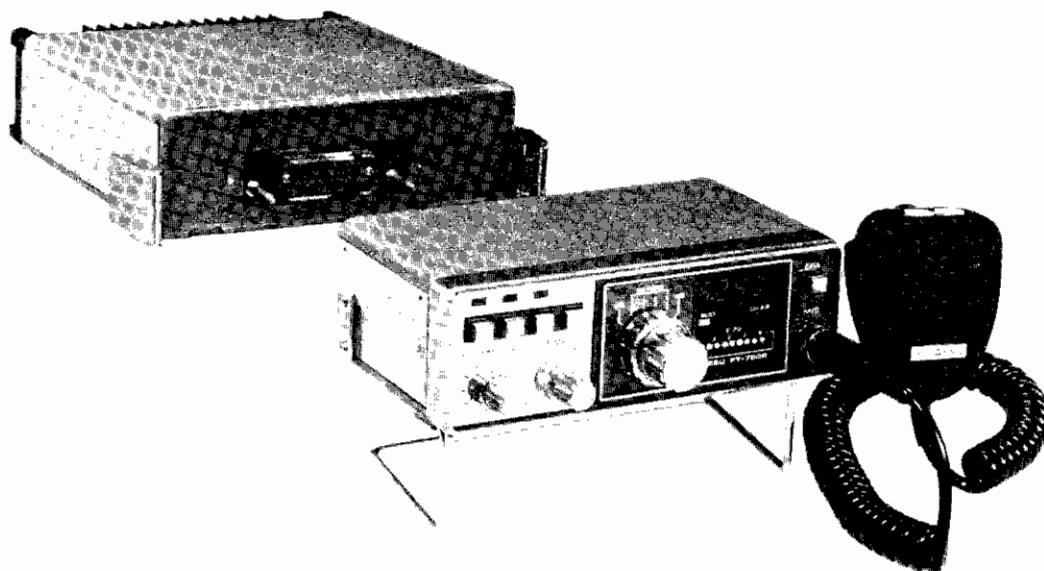

FRONT PANEL CONTROLS AND SWITCHES

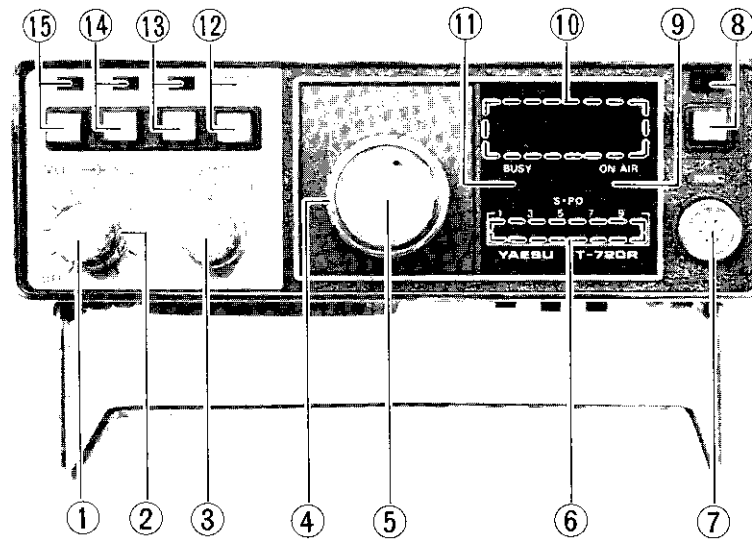

(1) VOL

The volume control sets the audio output level from the speaker. Clockwise rotation increases the audio output level.

(2) SQL

The squelch control quiets the receiver when no signal is received. This control should be set to the point where the background noise just disappears, in order to provide maximum sensitivity.

(3) SHIFT

This control selects up or down repeater shift, as well as simplex operation.

(4) M CH

This control selects the memory channel desired.

MS This position selects scanning of the memory channels.

RM This position selects memory operation on one receive channel, with transmit on the dial frequency.

M1–M4 These four memory channels may be used for storage and recall of any frequency within the range of the transceiver.

(5) CHANNEL SELECTOR

This knob controls the photo-interrupter system, for selection of the desired channel.

(6) S/PO

A string of LEDs provides indication of signal strength and relative power output.

(7) MIC

The six-pin microphone jack accepts the microphone input, as well as PTT (push-to-talk) and scanning control lines.

(8) CALL

When this button is pushed, the PTT line will be closed, and a 1800 Hz or 1750 Hz (depending on your local requirements) tone will be transmitted, for accessing repeaters. When the CALL button is pushed, the lamp above the button will become illuminated.

(9) ON AIR

This LED lights up while you are transmitting.

(10) DISPLAY

Digital display of the last four digits of the operating frequency is provided.

(11) BUSY

This LED lights up when the channel is occupied.

(12) DIAL

This button selects frequency control by way of the main channel selector.

(13) MR

Press this button to select memory channel recall.

(14) PRI

This button selects priority channel operation.

(15) M

Press this button to store a frequency in memory.

REAR APRON CONNECTIONS

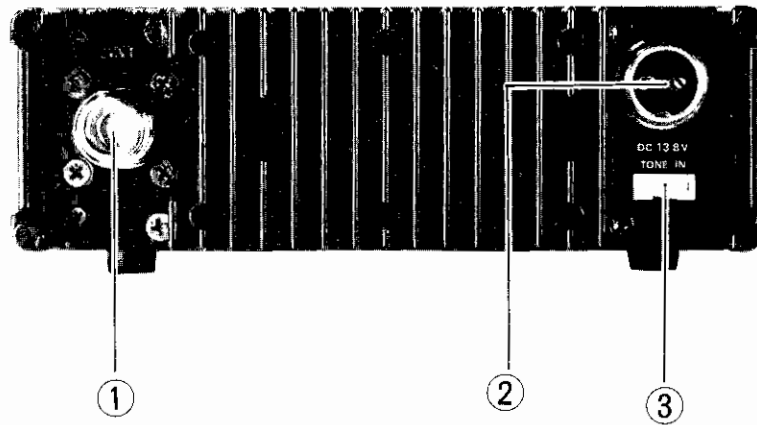

(1) ANT

Connect the antenna at this point. For 2 meters, use a type SO-239 plug, and for 70 cm use a type N connector.

(2) DC 13.8V (DC 13.6V RVH model)

Connect the DC power cord at this point. Never

apply AC power, or improper DC input voltages, to this transceiver.

(3) TONE IN CONNECTOR

This connector is provided for the external Tone Encoder FTS-64, which oscillates 32 CTCSS or Tone-burst frequency. (Optional)

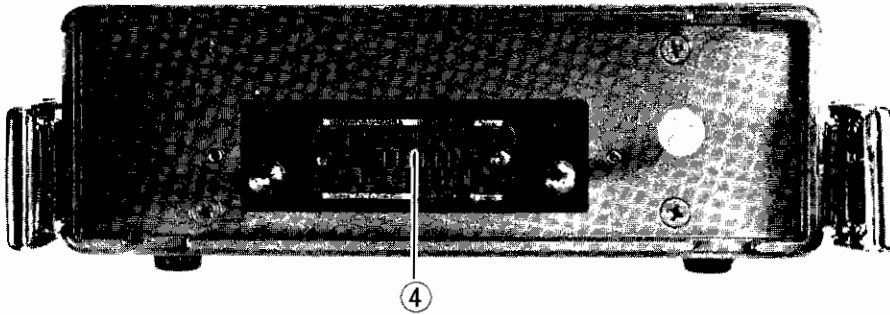

720RV,720RU FRONT VIEW

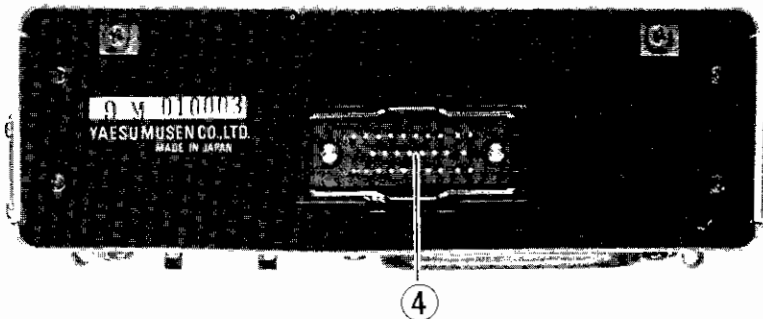

FT-720R REAR VIEW

(4) INTERFACE CONNECTOR

All control lines from the control head to the RF deck are fed through the interface connector. An optional interface cable is available from your Yaesu dealer, allowing the RF deck to be located away from the control head.

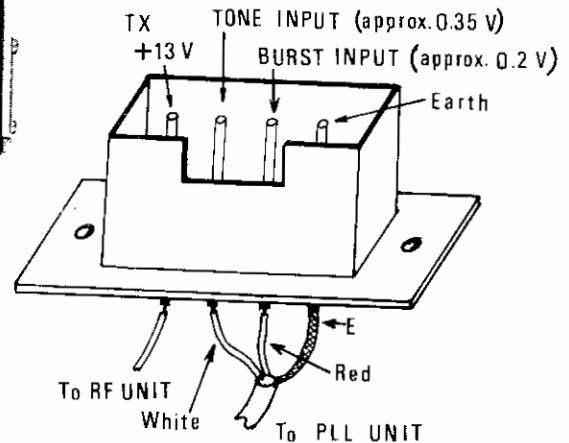

TONE IN CONNECTOR

BOTTOM PANEL

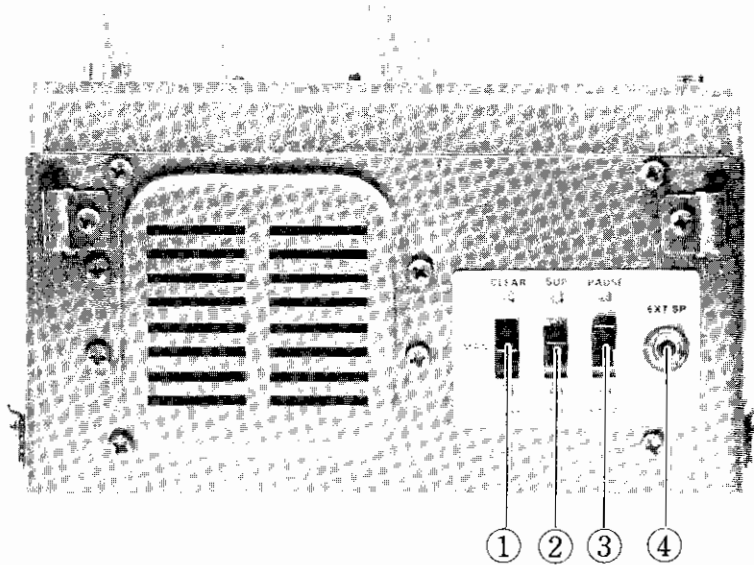

(1) BUSY-MAN-CLEAR

This switch will select scanning stop on a busy or clear channel. Manual scanning stop control is also provided.

(2) 5 UP

This switch will shift the channel frequency 5 kHz up.

(3) PAUSE

This switch will instruct the microprocessor regard-

ing scanning restart following a stop command. In the PAUSE position, the scan will restart after the stop command is removed, while in the STOP position, the scanning will not restart without your manual command. See the "Operation" section for details.

(4) EXT SP

An external speaker may be connected at this point. Insertion of the speaker plug into this jack automatically cuts off the internal speaker.

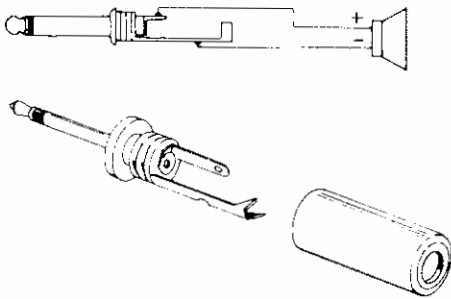

EXTERNAL SPEAKER CONNECTIONS

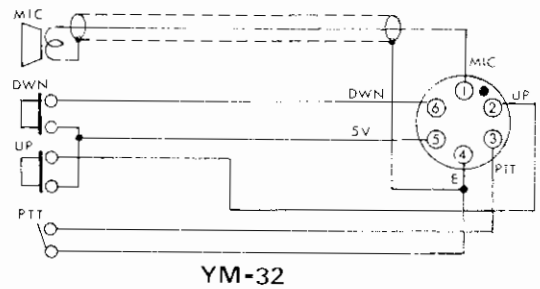

YM-32

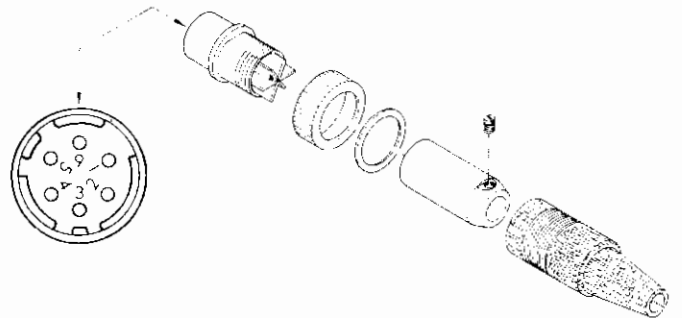

YM-32 MICROPHONE CONNECTIONS

INSTALLATION

The FT-720R transceiver is designed primarily for mobile applications, requiring only an antenna and 13.8 VDC (13.6 VDC for RVH model) power source for operation. This equipment has been pre-tuned at the factory, and requires no adjustment for normal operation into a 50 ohm load.

The antenna and its location are of critical importance in both mobile and base station service. Communications range is directly related to antenna height; therefore, the base station antenna should be located as high and in the clear as possible. A spacing of at least five feet (1.5 meters) should be maintained between the VHF or UHF antenna and other arrays. In mobile applications, the antenna should be situated as far from the engine as possible, in order to avoid unnecessary noise pickup. In all installations, the antenna SWR should be kept below 1.5:1.

For base station installations, the most popular antennas are the 1/4 wavelength vertical, the stacked dipole type of array, and the Yagi antenna, used alone or in stacked arrays. Vertical polarization, having been almost universally accepted around the world, should be used.

To minimize losses in the antenna system, the shortest possible length of coaxial cable should be used. For mobile applications, type RG-58A/U is suitable because of its small size. For base station runs of 25 feet (about 7.5 meters) or longer, type RG-8A/U is recommended, and for extremely long coax runs, type RG-17A/U, aluminum-jacketed "foamflex" coax, or air-dielectric "heliac" cable should be used. For the connection to the FT-720RU 70 cm deck, please use a constant-impedance type N connector. And see your Yaesu dealer for details of the Yaesu line of VHF and UHF antennas.

MOBILE INSTALLATION

For mobile installations, the most popular antennas are the 1/4 wavelength vertical, and the 5/8 wavelength vertical, which provides approximately 3 dB gain over the 1/4 wavelength antenna. Mobile antennas are available from your Yaesu dealer.

For mobile service, the FT-720R should be mounted where the controls, switches, and digital display are easily accessible for operation. The control head may be installed separately from the RF deck, with the two units then using connected together by means of the optional remote cable, available from your Yaesu dealer. A second mounting bracket may be obtained from your Yaesu dealer as an option, should you decide to mount the two units separately.

The FT-720R may be mounted in any position without loss of performance. A suitable location would be under the dash board, atop the transmission tunnel. Refer to the drawings below for mounting details.

- (1) Use the universal mounting bracket as a template for positioning the mounting holes. Use a 3/16" diameter bit for drilling these holes, allowing clearance for the transceiver, its cables and microphone, and its controls. Secure the mounting bracket with the screws, washers, and nuts supplied, as shown in the drawing.
- (2) Ease the transceiver into the guide rail, and slide it into the desired position. The optimum position for securing the transceiver is one where the fastening knobs are positioned slightly in back of the junction between the control head and the RF deck. However, you may secure the transceiver at the control head without fear of damaging your set, as the construction is very rugged.
- (3) Tighten the knobs on the outside of the universal bracket to secure the transceiver.
- (4) The microphone hanger may be installed wherever convenient for access to the microphone.
- (5) In all installations, the RF deck should not be situated near the output vent from the car heater, nor should it ever be exposed to moisture. Do not allow the heat sink to rest directly on the car upholstery, as this will interfere with heat sink performance, and the dissipated heat might damage the upholstery.

When making power connections in a mobile installation, we highly recommend that the power cable be routed directly to the battery, instead of to the ignition switch or fuse block. When the transceiver power is turned off, the memory backup circuitry will hold all frequencies stored in memory if 13.8 VDC (13.6 VDC for FT-720RVH) is present at the rear apron DC input jack. Current drain is negligible in the backup mode. If you connect the FT-720R to a switched power circuit, the memory frequencies will have to be stored again when you begin operation anew.

If it is necessary to extend the power cable, use #16 AWG insulated copper wire, and use the minimum length necessary to reach the battery terminals.

Connect the RED power lead to the POSITIVE (+) battery terminal, and connect the BLACK lead to the NEGATIVE (-) battery terminal.

Before connecting the power cable to the transceiver, check the battery voltage with the engine running fast enough so that the vehicle ammeter shows a "charge". If the voltage exceeds 15 VDC, the automobile voltage regulator must be adjusted so that the absolute maximum charging rate is 15 VDC. Be absolutely certain to recheck the battery voltage if the voltage regulator has been serviced. When making battery connections, be absolutely certain to observe the proper polarity. Reversed polarity will not damage the FT-720R because of the protective circuitry incorporated in design; however, the transceiver will not operate under conditions of reversed supply polarity.

A DC fuse is located in the power cable. For the 25 watt FT-720RVH deck, use only a 10 amp fuse. For the 10 watt FT-720RV and the FT-720RU 70 cm deck, use only a 5 amp fuse.

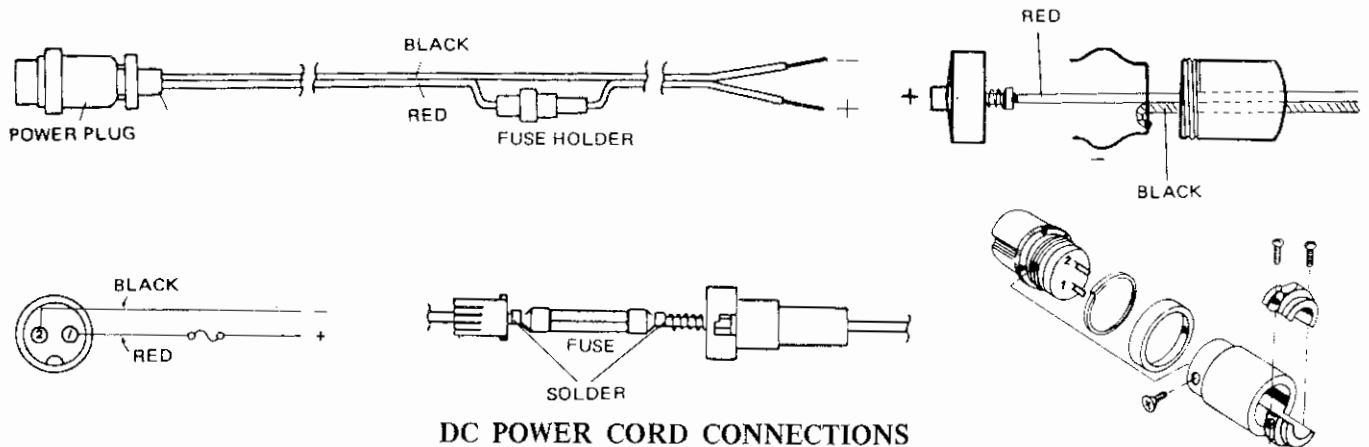

CAUTION

BE ABSOLUTELY CERTAIN THAT A FUSE OF THE PROPER RATING IS USED. OUR WARRANTY DOES NOT COVER DAMAGE CAUSED BY USE OF AN IMPROPER FUSE OR IMPROPER SUPPLY VOLTAGE.

CONTROL HEAD/RF DECK INTERCONNECTION

The FT-720R control head may be used with either the 2 meter or 70 cm RF deck. The control head and RF deck may be clamped together to form a single unit, or they may be located separately and joined by way of the optional remote cable, available from your Yaesu dealer.

To separate the control head and the RF deck, release the fastening clamps located on each side of the transceiver. Now gently ease the two modules apart, being careful not to force the units apart at a sharp angle.

To connect the two modules, use the two guide pins located on the RF deck to ensure proper alignment (it is impossible to connect the two units in reversed fashion). Ease the control head interface plug into the matching jack on the RF deck, and clamp the two units together to complete the assembly procedure. The resulting assembly is extremely rugged.

For switching between the VHF and UHF RF decks, a special switching box is available. See your Yaesu dealer for details of the S-72 switching box. This will turn your control head into a two-band transceiver control system.

INSTALLATION STEP-BY-STEP OUTLINE

1. Determine the optimum location for the transceiver, making certain that there is sufficient space for the transceiver, its cables and switches, and the microphone. Leave several inches of space around the heat sink, to permit free air flow.
2. A universal bracket is supplied with the transceiver. Use the universal bracket as a template for positioning the mounting holes. Use a 3/16" diameter bit for drilling these holes, allowing clearance for the transceiver and all accessories and cables. Mount guide rails to the transceiver as shown in the picture. Secure the mounting bracket with the screws, washers, and nuts supplied, as shown in the drawing.
3. Ease the transceiver into the guide rail, and slide it into the desired position. Tighten the knobs on the outside of the universal bracket to secure the transceiver.

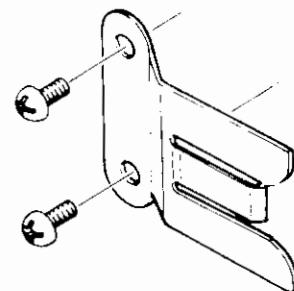
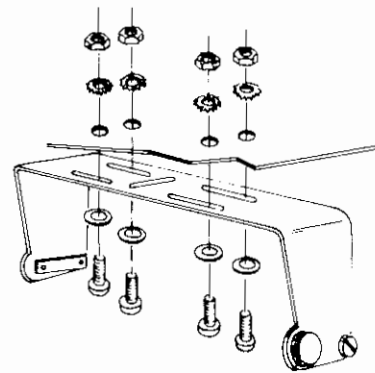
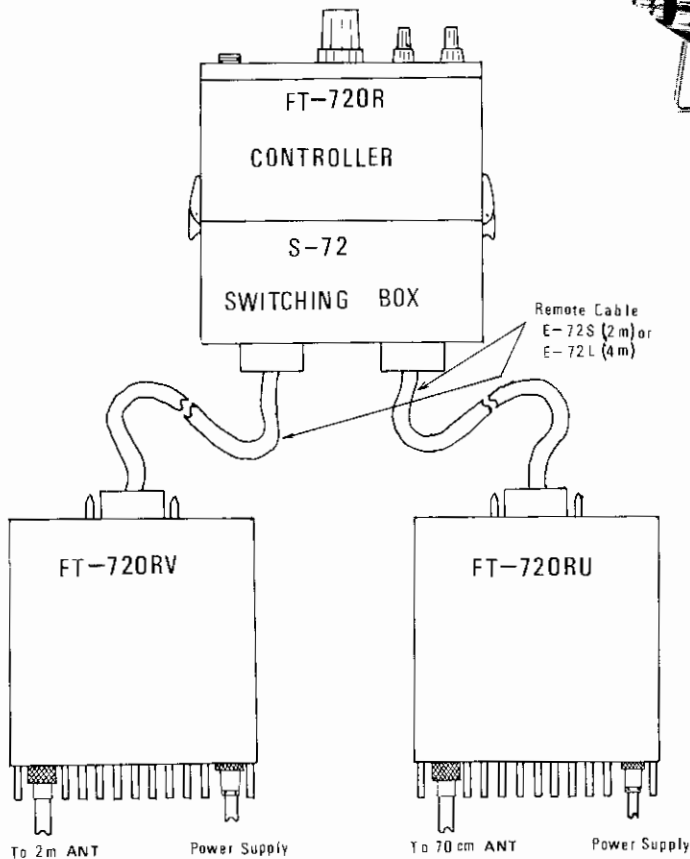
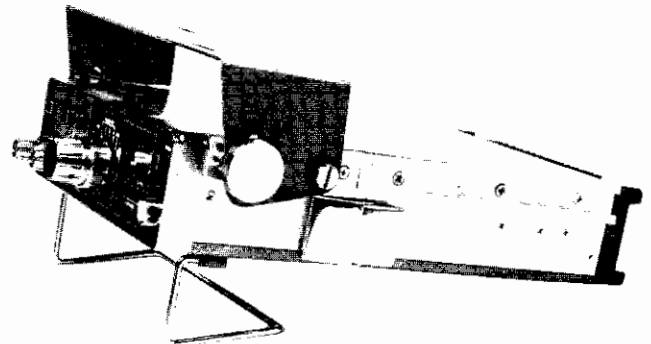
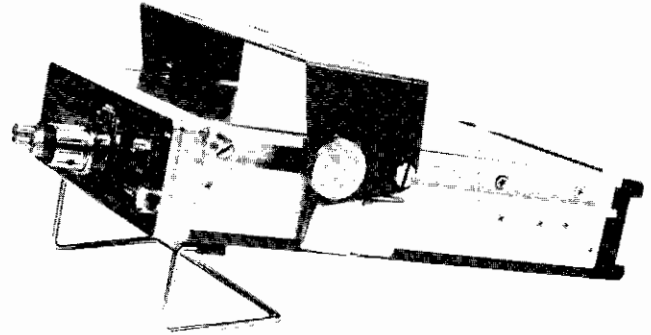
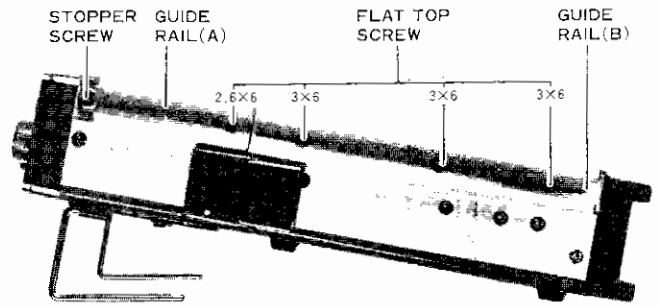

SWITCHING BOX CONNECTIONS

OPERATION

In this section, we will provide examples of typical operation, using the FT-720RV and FT-720RU "A" models for illustration, unless otherwise noted. See the model charts at the front of this manual for details of the differences in tone frequencies, frequency range, and preset frequencies.

Before commencing operation, confirm that all power connections have been properly made, and that a 50 ohm antenna has been connected to the antenna jack.

INITIAL CHECK

- (1) Rotate the SQL control fully counterclockwise. Rotate the VOL control clockwise out of the click-stop to apply power to the transceiver. Adjust the VOL control for a comfortable listening level. The initial frequency displayed on the digital readout will be 147.000 MHz (2 meters, model A) or 446.000 MHz (70 cm, model A). The last four digits of the operating frequency are displayed, and a display sample showing the above preset frequencies is shown below.
- (2) When the channel is clear, rotate the SQL control to the point where the background noise is just silenced. Do not rotate the SQL control much beyond this threshold point, or else the receiver will not respond to weak signals.

FREQUENCY SELECTION USING MAIN DIAL

When the transceiver is initially turned on, frequency control will be via the main tuning dial. After memory operation, press the DIAL button to return control to the main dial.

Rotate the dial to secure the operating frequency desired. Depending on the model, the FT-720RV synthesizer steps are in 10 kHz or 12.5 kHz increments, while the FT-720RU synthesizer steps are each 25 kHz. In the 12.5 kHz models, a small figure "5" will appear in the lower right-hand corner of the display, to indicate the final digit of the operating frequency. An example showing the readout of the frequency 145.0125 MHz is provided below.

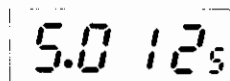

5.0 125

For the 10 kHz FT-720RV models, the 5 UP button on the bottom of the control head case will shift the channel frequency 5 kHz up, allowing operation on 147.955 MHz, for example.

When the upper or lower band edge is reached, the next synthesizer step will automatically be to the opposite band edge. Thus, after 147.990 MHz, the next step will be to 144.000 MHz. When a repeater split frequency falls outside the amateur band, the transmitter will be disabled, thus preventing illegal operation.

For MARS operation, the USA version of the FT-720RV is capable of operation down to 143.900 MHz.

Channel selection must not be made while the FT-720R is transmitting.

TRANSMISSION

Close the PTT (push-to-talk) switch to activate the transmitter. The red ON AIR lamp will become illuminated, and the LEDs on the PO scale will light up. When using a 50 ohm load at the antenna jack, all seven of the yellow LEDs and two red LEDs will be illuminated.

Hold the microphone close to your mouth, and speak in a normal voice into the microphone. Release the PTT switch for receiver recovery.

MEMORY OPERATION

A total of five memory channels are available for operation. Storage and recall of memory channels allows considerable operating flexibility. The storage and recall procedure is extremely simple:

- (1) Rotate the main dial to the desired channel (for example, 146.520 MHz). Now rotate the M CH (memory channel) switch to position 1. Press the M button to store 146.520 MHz into memory channel position 1.
- (2) Now rotate the channel selector to another channel (e.g. 146.490 MHz). For instant return to 146.520 MHz, press MR. The lamp above the MR button will become illuminated, and 146.520 MHz will be displayed on the

digital readout.

- (3) To return again to 146.490 MHz, press DIAL. The lamp above the DIAL button will light up, and you will be operating on 146.490 MHz.
- (4) Memory channels 2, 3, and 4 may be programmed in like fashion. Picking up where we left off in step (3), with 146.490 MHz on the dial, rotate the M CH switch to 2 and press M to store 146.490 MHz in memory channel 2. Rotate the main dial to 146.550 MHz, set the M CH switch to 3, and press M to store that frequency in memory. Now rotate the main dial to 146.580 MHz, set the M CH switch to 4, and press M to store 146.580 into that memory channel. You may now recall the desired frequency by pressing MR and rotating the M CH switch as needed.
- (5) For split frequency operation, the M0 channel may be used. In this case, you will store the receive frequency in memory, then rotate the main dial to the desired transmit frequency. For example, rotate the main dial to 146.490 MHz, set the M CH switch to RM, and press M. Now rotate the main dial to 146.550 MHz. Press MR to recall 146.490 MHz, the receive frequency. When you close the PTT switch, the display will indicate the transmission frequency, 146.550 MHz.

REPEATER OPERATION

Repeater split is provided on both the FT-720RV and FT-720RU. Your Yaesu dealer will be stocked with the unit equipped with the proper repeater split for your area. Refer to the model chart at the front of this manual for a listing of the available repeater splits.

The front panel SHIFT switch will determine the direction of the split. Using the 2 meter model A as an example, set the SHIFT switch to the - position for -600 kHz shift. For +600 kHz shift, switch to +. For simplex operation, set this switch to SIMP.

To cover unusual repeater splits, you can use the M0 feature of the memory to provide coverage of

repeaters not within the normal capability of this transceiver. For example, to achieve 7.6 MHz split on the FT-720RU, use the following procedure, using one of the European repeater channels as a model. Rotate the main dial to 438.600 MHz, set the M CH switch to RM, and push M. Now set the main dial to 431.000 MHz, and press MR. You will now be receiving on 438.600 MHz, and transmitting on 431.000 MHz, the dial frequency.

A 1750 Hz or 1800 Hz tone generator is included with your transceiver, for accessing repeaters requiring such a tone.

The tone may be activated manually by pressing front panel CALL switch. The CALL switch will activate the PTT function, and transmit the access tone, for as long as the switch is held.

The tone frequency can be determined by the following formula.

$$\text{Crystal frequency} = \text{Tone frequency} \times 2048 \text{ (multiplier)}$$

Fingertip controls located on the microphone allow convenient frequency control while driving. The simple operating procedure is described below.

- (1) Set the bottom panel BUSY-MAN-CLEAR switch to the MAN position. Push the DIAL switch to select operation on the dial frequency.
- (2) Press the microphone UP switch for an instant to shift the channel frequency 10 kHz up. If you hold the UP button for more than 1/2 second, the scanner will be activated. To stop the scan, press the PTT switch, the front panel CALL switch, or one of the scanning controls on the microphone. If you push the PTT or CALL switch, no transmission will occur; release the PTT or CALL switch, then press it again, for normal transmission.
- (3) To scan lower in frequency, use the same procedure, but press the DN button.
- (4) To halt the scan automatically on a busy channel, set the bottom panel BUSY-MAN-CLEAR switch to BUSY. In this mode, when the scanner encounters a signal strong enough to open the receiver squelch, scanning will stop. When the bottom panel switch is placed

in the CLEAR position, the scan will stop when a clear channel (one where the squelch will not open) is found.

- (5) The bottom panel PAUSE switch may be used for automatic restart of the scan, in conjunction with the setting of the BUSY-MAN-CLEAR switch. For example, if you have the scan stop switch set to BUSY, and the scanner finds a busy channel, the scan will be halted. With the restart switch in the PAUSE position, the scan will restart after the channel becomes clear (BUSY lamp turns off). With the restart switch in the STOP position, the scan will not restart.

Likewise, with the scanning stop switch in the CLEAR position, and the restart switch in the PAUSE position, the scan will stop on the first clear channel that is encountered; if the channel becomes occupied, the scan will restart after 2.5 seconds of the squelch being open.

- (6) Care should be observed when using the PAUSE mode. For example, if you are talking to a station on a crowded channel, and ask the other station to follow you up to "the first clear channel," be sure to put the scan restart switch in the STOP position. If you do not, with the scan stop switch in the CLEAR position, the radio will begin scanning after 2.5 seconds if the other station calls you on a previously unoccupied channel.

However, if you push the PTT switch, the PAUSE command in the microprocessor will be reset, and scanning will not restart until you manually initiate a scan again. Therefore, in the above example, if you call the other station on the "first clear channel," the auto scan will not restart, regardless of the position of the PAUSE switch.

- (7) To scan only the memory channels, rotate the M CH switch to the MS(memory scan) position. Now press either the UP or DN switch on the microphone (either will activate the scan in the identical direction: M1-M2-M3--M4-M1 ...). The scanning rate for the memory scan mode will be approximately two

channels per second. The scan may be halted in any of the ways discussed previously. The use of the BUSY and PAUSE modes is particularly helpful when scanning the memory channels.

PRIORITY CHANNEL OPERATION

A priority channel may be used in conjunction with a memory channel, for increased flexibility. Here is how to set up the FT-720R for priority operation:

- (1) First program one or more memory channels. For example, store 146.640 MHz into memory channel 2. Now rotate the main dial to a new frequency (e.g. 146.520 MHz). Set the M CH switch to 1, and push MR to recall 146.640 MHz. Set the bottom panel scan stop switch to MAN.
- (2) Now press the PRI (priority) switch. For approximately 2.5 seconds, 146.520 MHz will be indicated on the digital display. After that interval, the microprocessor will switch to memory channel 1 (146.640 MHz) for 0.2 second. After another 2.5 seconds on 146.520 MHz, the microprocessor will again check 146.640 MHz.
- (3) If you have other frequencies stored in memory, you may rotate the M CH selector to select another channel for use with the priority channel. However, to set up another priority channel, you must first push the DIAL switch, then rotate the dial to the desired priority channel. Rotation of the main dial with the MR button pushed will have no effect on the operating frequency.
- (4) You may use the scan stop switch to good advantage during priority channel operation. For example, if you set the scan stop switch to BUSY, the search between the memory and the priority channel will halt when a signal is encountered. The search may also be halted by pressing the PTT or CALL switch. The PAUSE and STOP switch works in the same way as during scanning operation.

- (5) If you wish to return to normal operation from the priority mode, push the **PRI** button again. The **MR** lamp will now be illuminated. You will be operating on the selected memory channel, and you may press the **DIAL** button, as usual, for operation using the main tuning dial. When the **PRI** lamp is illuminated, pressing the **MR** or **DIL** buttons will have no effect; you must first press the **PRI** button to switch the microprocessor out of the priority mode.

INITIALIZING FREQUENCY/BACKUP FEATURE

The FT-720R includes a backup feature which will hold all memory frequencies, as well as the dial frequency, when the front panel power switch is turned off. So long as the DC power to the rear apron power jack is not interrupted, these frequencies will be held. When the power is again turned on, the frequency and mode (memory, dial, etc.) last used will be recalled.

However, if the power cord is unplugged, or if the power cord is connected to a 13.8 VDC circuit that is switched off along with the automobile ignition, all memory channels, as well as the dial frequency, will be reset to the preset frequency shown in the model chart at the front of this manual.

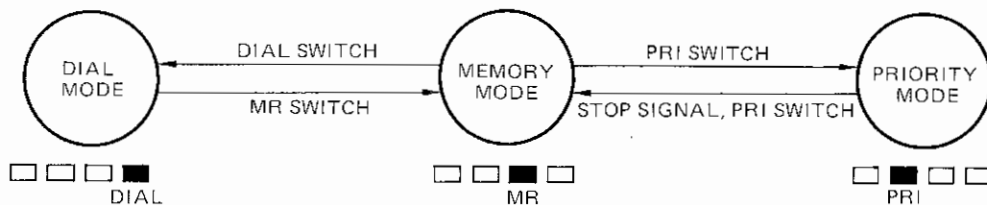

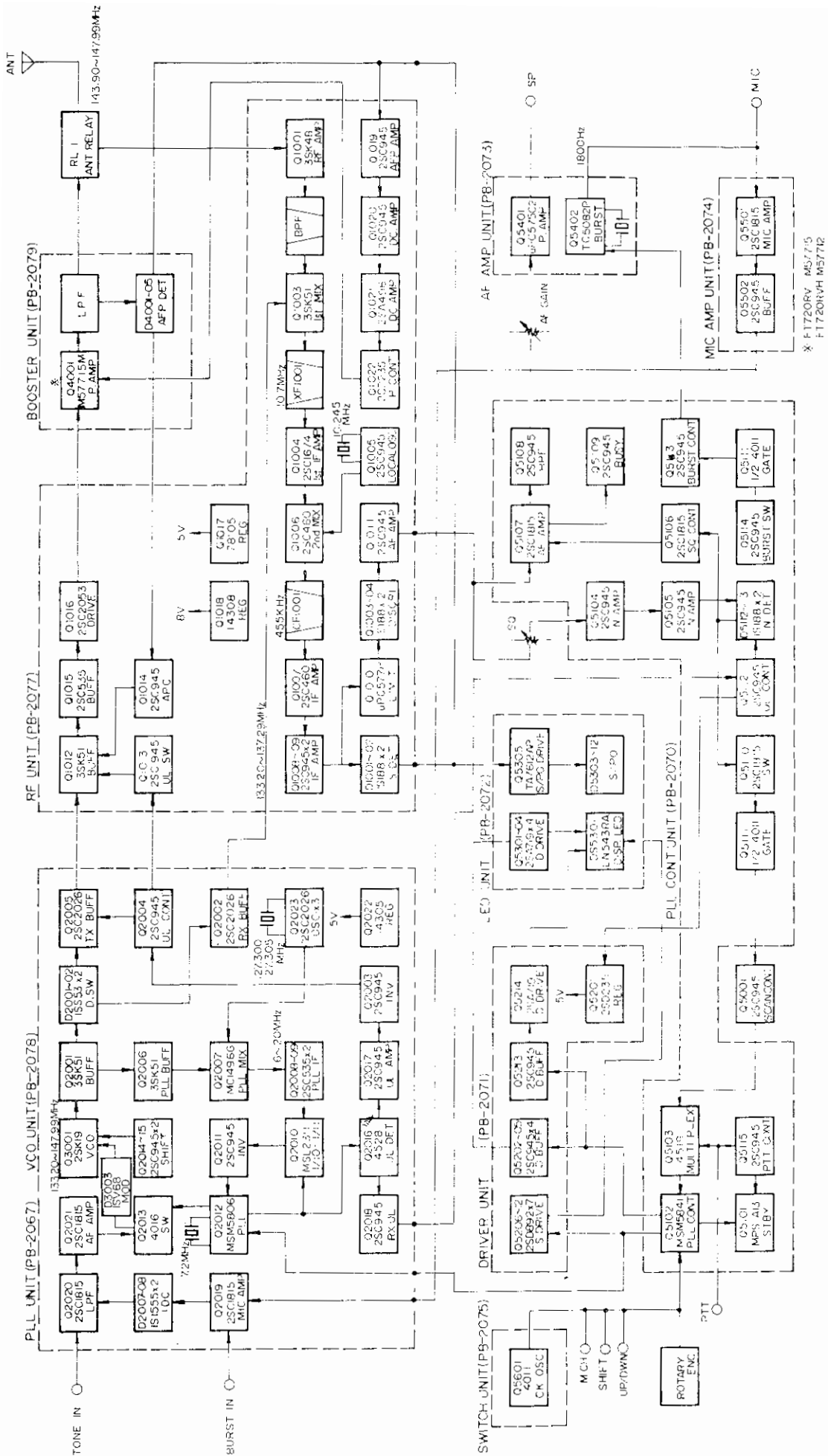

FT-720RV
BLOCK DIAGRAM

20UEU4

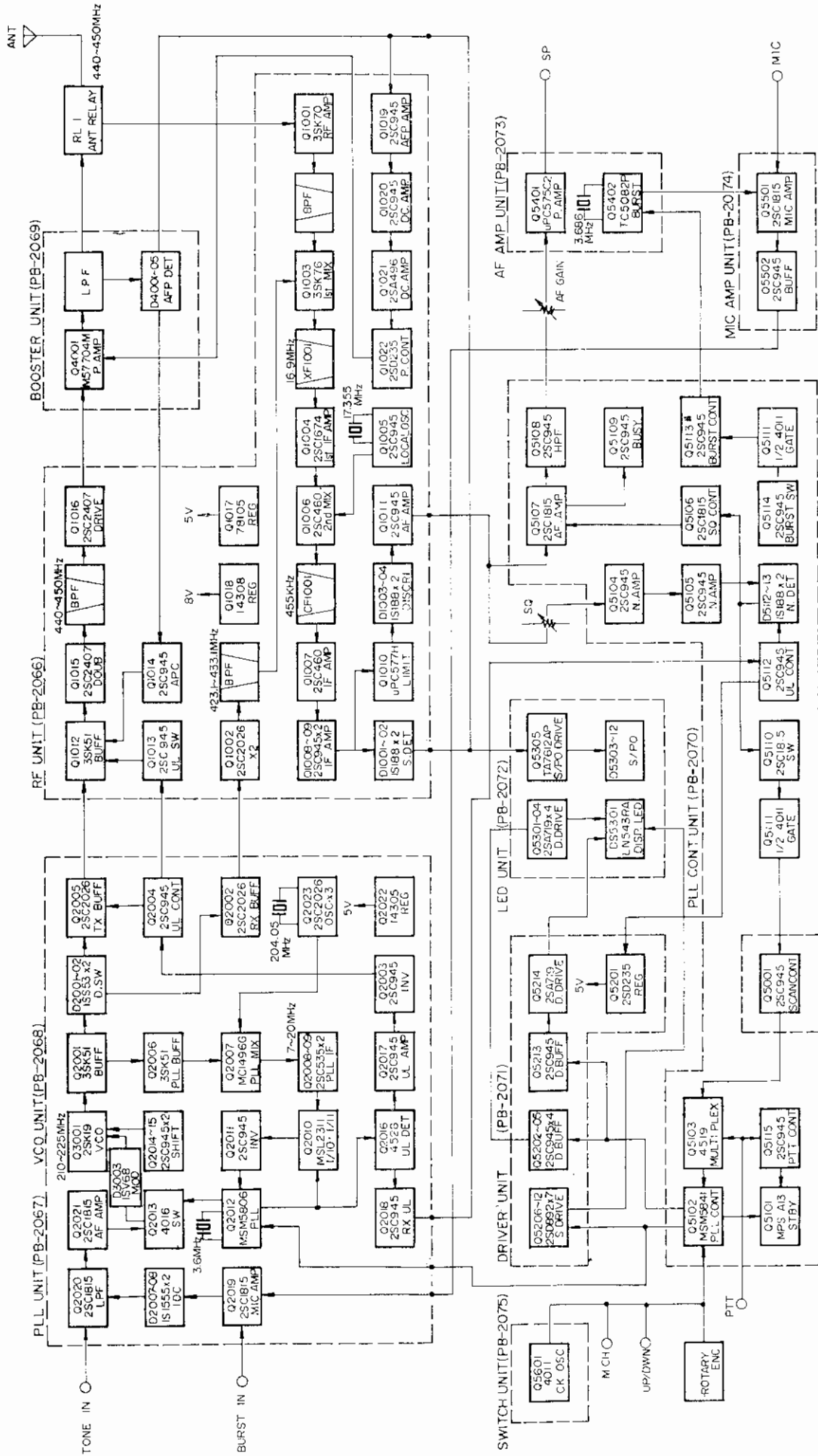

FT-720RU
BLOCK DIAGRAM

70U

CIRCUIT DESCRIPTION

The block diagram and circuit description to follow should provide you with a better understanding of the design of this equipment. Please refer to the schematic diagram for specific circuit details.

This circuit description will cover both the FT-720RV and FT-720RU models. Where a difference in component value or nomenclature occurs, the value pertaining to the FT-720RU will be shown in parenthesis, with two asterisks. For example, the first IF will be shown as 10.7 MHz (**16.9 MHz). This should be understood to mean that the FT-720RV first IF is 10.7 MHz, while the first IF of the FT-720RU is 16.9 MHz.

RECEIVER

The input signal from the antenna is fed through antenna relay RL_1 to the RF amplifier, Q_{1001} (3SK48) (**3SK70) and passed through a bandpass filter for delivery to gate 1 of the first mixer. In the FT-720RU, a cavity filter is used for high performance. The RF signal at gate 1 of mixer Q_{1003} (3SK51) (**3SK76) is mixed with a 133–137 MHz (**413–423 MHz or 423–433 MHz) local signal, producing a 10.7 MHz (**16.9 MHz) first IF.

The IF signal is passed through crystal filter XF_{1001} and fed to second mixer, where the IF signal is mixed with a 10.245 MHz (**16.445 MHz or 17.335 MHz) local signal from crystal oscillator Q_{1005} (2SC945), producing a 455 kHz second IF. The 455 kHz signal is passed through ceramic filter CF_{1001} and amplified by Q_{1007} (2SC460), Q_{1008} (2SC945), and Q_{1009} (2SC945).

The IF signal is then fed to limiter Q_{1010} (μ PC577H), where any amplitude variation in the IF signal is eliminated. The signal is then fed to the discriminator, which is composed of ceramic discriminator CD_{1001} and diodes D_{1003}/D_{1004} (1S188FM).

The discriminator produces an audio output in response to a corresponding frequency shift in the IF signal. The audio signal is amplified by Q_{1011} (2SC945), Q_{5107} (2SC1815), and Q_{5108} (2SC945), and fed through AF GAIN control VR_{5001} to audio PA Q_{5401} (μ PC575C2), which provides 1.5 watts of audio to the speaker. A high-pass filter at Q_{5108}

shapes the audio spectrum, while a de-emphasis network at Q_{5107} contributes low-pass filtering.

A portion of the output from Q_{1009} is detected by D_{1001} and D_{1002} (1S188FM), producing a DC voltage. This voltage is fed to an analog-to-digital converter, Q_{5305} (TA7612AP) which drives light emitting diodes D_{5303} – D_{5309} (LN422YP) and D_{5310} – D_{5312} (LN222RP) for indication of the relative strength of the incoming signal.

When no carrier is present in the 455 kHz IF, the high frequency (73 kHz) noise present at the output of Q_{1011} is amplified by Q_{5104} and Q_{5105} (2SC945) and detected by D_{5112}/D_{5113} (1S188), producing a DC voltage. This voltage activates switch Q_{5106} (2SC1815). As Q_{5106} conducts, the base of Q_{5107} is grounded, quieting the audio amplifier. When a carrier is present in the 455 kHz IF, the noise is removed from the discriminator output, and the audio amplifier then returns to normal operation.

The control voltage from the rectifier diodes is also delivered to switch Q_{5110} (2SC1815), which controls gate Q_{5111} (4011) and switch Q_{5001} (2SC945), providing STOP commands during auto scan operation of the scanner.

When the squelch circuit opens (Q_{5107} conducting), LED driver Q_{5109} (2SC945) draws current, causing the BUSY LED to light up.

The squelch threshold is preset by VR_{5101} , located on the PLL CONTROL Unit, while front panel control VR_{1b} provides for manual adjustment of the squelch threshold.

TRANSMITTER

The transmitter produces a frequency modulated signal. The audio signal from the microphone is set to the proper level by VR_{5501} , is amplified by Q_{5501} (2SC1815GR), and undergoes an impedance transformation at Q_{5502} (2SC945). The low impedance output from Q_{5502} is delivered to output connector P_{5001}/J_3 for transfer to the PLL Unit.

The input signal from the MIC AMP Unit is amplified by Q_{2019} (2SC1815GR) and applied to

the instantaneous deviation control (IDC), where both positive and negative peaks are clipped by D_{2007} and D_{2008} (1S1555). The output from the IDC is fed through an active low-pass filter at Q_{2020} (2SC1815GR) and amplified by Q_{2021} (2SC1815GR), and fed through switch Q_{2013} (4016) to the gate of voltage controlled oscillator (VCO) Q_{3001} (2SK19GR). The VCO, which operates on 144.0–147.99 MHz (**205–220 MHz or 210–225 MHz) in the transmit mode, is modulated by the speech signal applied to varactor diode D_{3003} (1SV68). The RF signal is then fed to buffer Q_{2001} (3SK51) and fed through diode switches D_{2001} and D_{2002} (1S1555), which feed the VCO output to the transmit or receive lines. The RF signal is fed through another buffer amplifier, Q_{2005} (2SC2016), and is then fed to the RF Unit.

On the RF Unit, the transmit signal is amplified at buffers Q_{1012} (3SK51) and Q_{1015} (2SC535) and fed to driver Q_{1016} (2SC2053) (**2SC2407). On the FT-720RU, the output from Q_{1012} is fed to doubler Q_{1015} (2SC2407) and fed through a band-pass filter prior to delivery to Q_{2016} . The output from the driver stage is then delivered to the PA.

The RF signal is amplified by Q_{4001} (M57715/10W or M57712/25W) (**M57704M) and fed through a low-pass filter and the antenna relay to the antenna.

A portion of the output from the power amplifier is rectified by diodes D_{4001} – D_{4005} (1S188FM), producing a DC voltage. This voltage is amplified by Q_{1014} (2SC945) and fed to gate 2 of Q_{1015} , controlling the gain of that stage. Control voltage is also amplified by Q_{1019} , Q_{1020} (2SC945), Q_{1021} (2SA496), and Q_{1022} (2SD235) to control the gain of the final amplifier power module. When the rectifier diodes detect high reflected power on the feedline, the amplifier transistors are instantaneously protected against damage by reduction of the voltage applied to that stage.

PLL CIRCUIT

A Phase Locked Loop (PLL) circuit is used for the receiver first local oscillator and the transmitter fundamental signal. The PLL consists of a programmable divider, a prescaler, and a phase detector. The PLL design technique ensures high stability and excellent rejection of spurious signals. A detailed explanation of the PLL circuitry is found below.

VCO/VCO SHIFT CIRCUIT

The Voltage Controlled Oscillator (VCO) is a Clapp type circuit, using Q_{3001} (2SK19GR) as the oscillator FET. The VCO generates the transmitter carrier and the receiver first local oscillator, with the frequency shift of 10.7 MHz (**8.45 MHz) being provided by a diode switch in conjunction with the following frequency-determining parts: L_{3004} , C_{3008} , C_{3009} , C_{3013} , C_{3014} , D_{3002} , and D_{3003} (** L_{3004} , C_{3006} , C_{3007} , C_{3008} , C_{3012} , C_{3013} , TC_{3002} , D_{3002} , and D_{3003}), as well as some other parts (as seen below).

Diode switch D_{3001} (1SS53) is in series with C_{3004} and TC_{3001} , which are situated between C_{3008} and D_{3002} . In the receive mode, the diode switch is activated, placing C_{3004} and TC_{3001} in the VCO line (in series), while on transmit C_{3004} and TC_{3001} are switched out of the circuit. In the FT-720RU, TC_{3001} is placed in parallel with the tuned circuit of the VCO. The diode switch is controlled by transistor switches Q_{2014} and Q_{2015} (2SC945P), which provide RX 8V and TX 8V, respectively, to the VCO. In the transmit mode, C_{3004} and TC_{3001} are placed in series with varactor diode D_{3002} , which controls the VCO frequency.

A single-IC PLL chip is used in this transceiver. The output from the VCO transistor is buffered at Q_{2001} (3SK51) and fed through diode switch D_{2001} or D_{2002} (1SS53), depending on the mode (TX/RX) of operation. The transmit signal is further buffered at Q_{2005} (2SC2026) and delivered to the RF Unit, the RX signal is buffered at Q_{2002} (2SC2026) for delivery to the receiver first mixer.

PLL IF CIRCUIT

A portion of the output from Q_{2001} is fed through PLL buffer Q_{2006} (3SK51) and delivered to the PLL mixer, Q_{2007} (MC1496G), where the VCO signal is mixed with a 127.30 MHz (**199.05 or 204.05 MHz) signal, producing a 6.00–9.99 MHz (**6.00–10.99 MHz) PLL IF for the receive mode. On transmit, the PLL IF is 16.7–20.69 MHz (14.45–19.44 MHz). The PLL IF signal is fed through buffer amplifiers Q_{2008} and Q_{2009} (2SC535) for delivery to the programmable divider. The PLL heterodyne signal is generated by crystal oscillator Q_{2023} (2SC2026), which operates in the third overtone mode.

The main PLL circuitry is found on the PLL IC, Q_{2012} (MSM5806) and programmable divider Q_{2010} (MSL2311), which acts as a prescaler controlled by logic commands from the PLL IC. Please refer to the chart for details of the different divider ratios used in the main PLL.

The incoming PLL IF signal is divided by either 10 or 11, according to the instructions of the PLL chip. The PLL IF signal is then fed through inverter Q_{2011} (2SC945) to the PLL IC. There the PLL IF

signal is further divided into a 10 kHz signal, the phase of which is compared to that of a 10 kHz reference signal generated in the PLL IC. Any phase difference is converted into an error-correcting voltage, which is fed through Q_{2013} to varactor diode D_{3002} , thereby locking the VCO on the correct frequency.

During conditions of PLL unlock, an unlock voltage is developed by the phase detector in the PLL. This voltage is detected by Q_{2016} (4528), which controls disabling circuits in the transmitter and receiver stages. On RX, the receiver is quieted, and on transmit, the transmitter is disabled.

Please refer to Table 1 for details of the various frequency combinations used in the several models available. The PLL reference and intermediate frequencies vary from model to model.

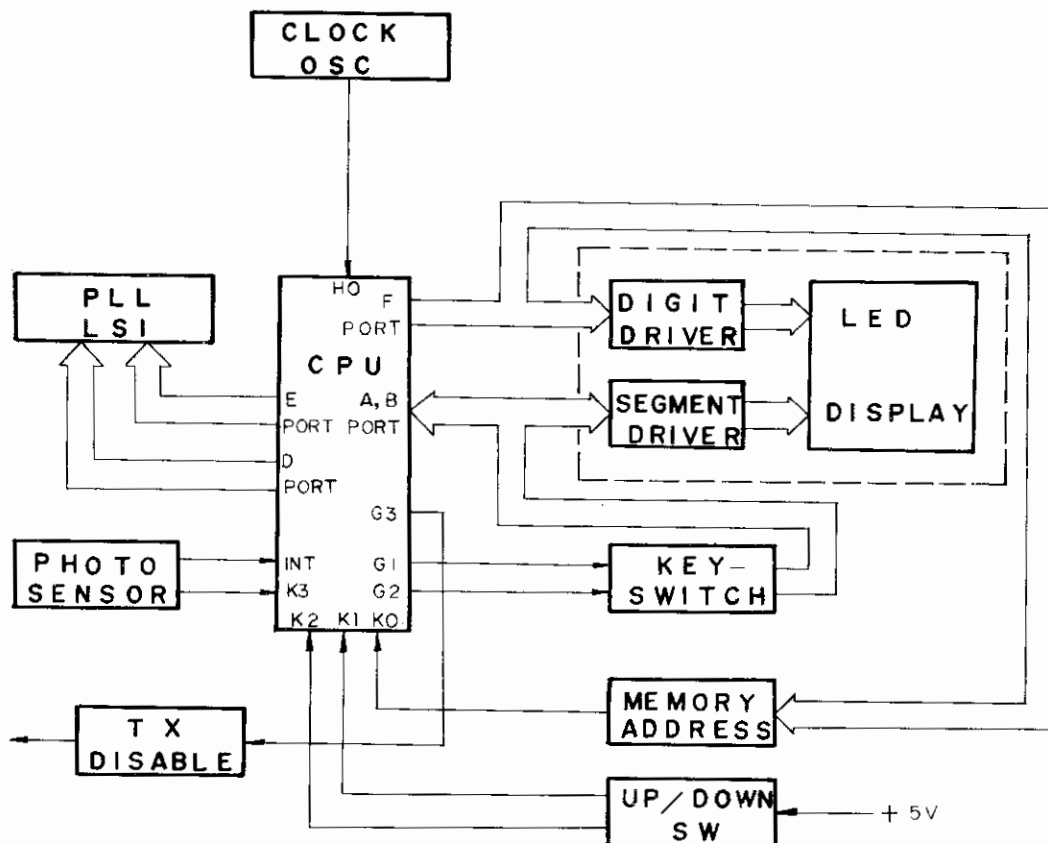

Frequency Combination Chart

MODEL	FT-720RV				FT-720RU			
	USA	EU1	EU2	EU3	EU4	USA (A)	USA (X)	FU (B)
BAND	143.9-147.99MHz	144.0-147.9875MHz	144.0-145.9875MHz	144.0-145.99MHz	143.9-147.99MHz	440-449.975MHz	430-439.975MHz	430-439.975MHz
CH STEP	10kHz	12.5kHz	12.5kHz	10kHz	10kHz	25kHz	25kHz	25kHz
RPT S/T	±600kHz	±600kHz	±600kHz	±600kHz	±600kHz	±5MHz	±5MHz	±1.6MHz
5kHz UP	○	X	X	○	○	-	-	-
X ₂₀₀₁ F	7.2MHz	3.6MHz	3.6MHz	7.2MHz	7.2MHz	3.6MHz	3.6MHz	3.6MHz
X ₂₀₀₂ F	127.300MHz	127.300MHz	127.300MHz	127.300MHz	127.300MHz	204.05MHz	199.05MHz	199.05MHz
X ₂₀₀₃ F	127.305MHz	-	127.300MHz	127.305MHz	127.305MHz	-	-	-
R ₂₀₄₁	1kΩ	-	-	1kΩ	1kΩ	-	-	-
R ₂₀₆₂	100kΩ	100kΩ	470Ω	470Ω	100kΩ	470Ω	470Ω	100kΩ
R ₂₀₆₆	470Ω	100kΩ	100kΩ	100kΩ	470Ω	470Ω	470Ω	470Ω
R ₂₀₈₄	100kΩ	470Ω	470Ω	100kΩ	100kΩ	470Ω	470Ω	470Ω
PLL OUT F (RX)	133.2-137.29MHz	134.3-137.2875MHz	134.3-135.2875MHz	134.3-135.29MHz	133.2-137.29MHz	211.55-216.5375MHz	206.55-211.5375MHz	206.55-211.5375MHz
PLL OUT F (TX)	143.9-147.99MHz	144.0-147.9875MHz	144.0-145.9875MHz	144.0-145.99MHz	143.9-147.99MHz	220-224.9875MHz	215-219.9875MHz	215-219.9875MHz
φ DET I/N (RX)	590-999	480-999	480-639	600-799	590-999	600-999	600-999	600-999
φ DET I/N (TX)	1660-2069	1336-1655	1336-1495	1670-1869	1660-2069	1276-1675	1276-1675	1276-1675
TP ₂₀₀₁ F (RX)	5.9-9.99MHz	6.0-9.9875MHz	6.0-7.9875MHz	6.0-7.99MHz	5.9-9.99MHz	7.5-12.875MHz	7.5-12.875MHz	7.5-12.875MHz
TP ₂₀₀₁ F (TX)	16.6-20.69MHz	16.7-20.6875MHz	16.7-18.6875MHz	16.7-18.69MHz	16.6-20.69MHz	15.95-20.9375MHz	15.95-20.9375MHz	15.95-20.9375MHz
TP ₂₀₀₁ LEVEL (p-p)	5V - 0.85V	5V - 0.85V	5V - 0.85V	5V - 0.85V	5V - 0.85V	5V - 0.85V	5V - 0.85V	5V - 0.85V
TP ₂₀₀₂ F	1.8MHz	900kHz	900kHz	1.8MHz	1.8MHz	900kHz	900kHz	900kHz
TP ₂₀₀₃ VOLTAGE	2.5 - 7V	2.5 - 7V	2.5 - 7V	2.5 - 7V	2.5 - 7V	3 - 6.5V	3 - 6.5V	3 - 6.5V
TP ₂₀₀₄ F	10kHz	12.5kHz	12.5kHz	10kHz	10kHz	12.5kHz	12.5kHz	12.5kHz
TP ₂₀₀₅ VOLTAGE	3 - 7V	3 - 7V	3 - 7V	3 - 7V	3 - 7V	2 - 6.5V	2 - 6.5V	2 - 6.5V
-tone BURST F	1800Hz	1750Hz	1750Hz	1750Hz	1750Hz	1800Hz	1800Hz	1750Hz
PRESET F	147.00MHz	145.00MHz	145.00MHz	145.00MHz	147.00MHz	446.00MHz	436.00MHz	433.40MHz

Note: This chart is not for type conversion.

Table 1

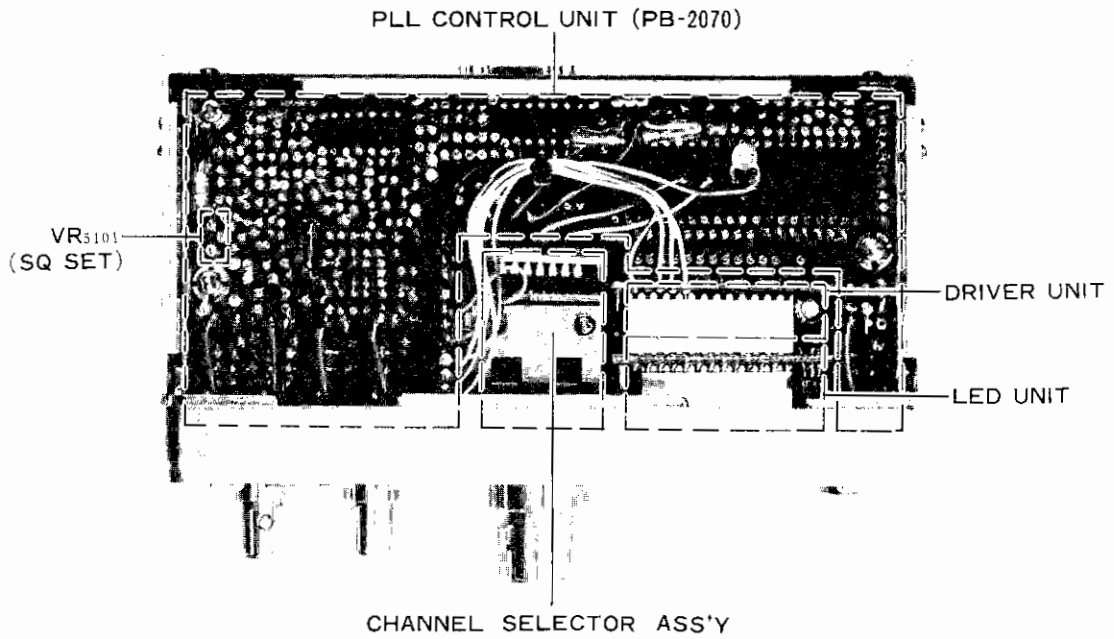

FT-720R TOP VIEW

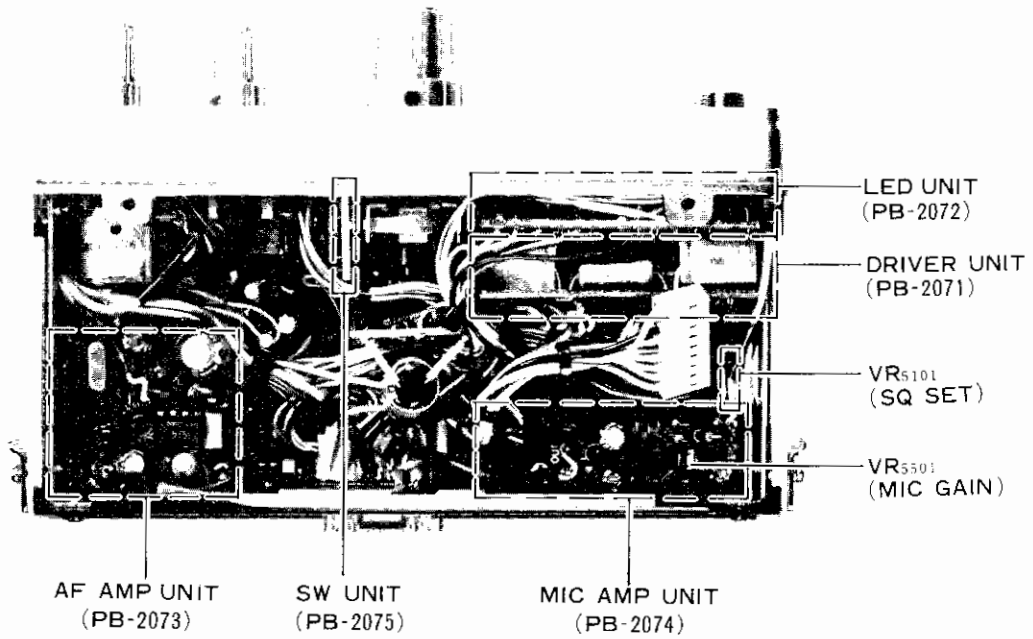

FT-720R BOTTOM VIEW

MAINTENANCE AND ALIGNMENT

This equipment has been carefully aligned and tested at the factory prior to shipment. If the instrument is not abused, it should not require other than the usual attention given to electronic equipment.

Service or replacement of a major component may require considerable realignment. Under no circumstances, though, should realignment be attempted unless the operation of the transceiver is fully understood, the malfunction has been carefully analyzed, and the fault has definitely been traced to misalignment rather than part failure. Service work must only be performed by experienced personnel using the proper test equipment.

Never align this transceiver without having a 50 ohm dummy load connected to the antenna jack, unless otherwise noted. Troubleshooting using an antenna can result in misleading indications on measuring equipment.

EQUIPMENT REQUIRED

- (1) RF Signal Generator: Hewlett-Packard Model 8640B or equivalent, with one volt output at 50 ohms, and frequency coverage to 450 MHz.
- (2) Vacuum Tube Voltmeter (VTVM): Hewlett-Packard Model 410B or equivalent, with an RF probe good to 500 MHz.
- (3) Dummy Load/Wattmeter: Bird Model 3343-200
Bird Model 43+25-E
- (4) AF Signal Generator: Hewlett-Packard Model 200 AB or equivalent.
- (5) IF Sweep Generator capable of output at 10.7 MHz (FT-720RV) and 16.9 MHz (FT-720RU).
- (6) RF Sweep Generator capable of output at 143-149 MHz (FT-720RV) and 410-460 MHz (FT-720RU).
- (7) An Oscilloscope
- (8) FM Deviation Meter
- (9) Precision Frequency Counter, Yaesu Model YC-500 or equivalent, with resolution to .01 kHz and frequency coverage to 500 MHz.

ALIGNMENT PROCEDURE

Make all alignments with the channel switch set to 145 MHz (FT-720RV, 2 MHz model), 147 MHz (4 MHz model), 435 MHz (FT-720RU, 430-440 MHz model), or 445 MHz (440-450 MHz model).

PERFORMANCE CHECKS

Make all performance checks at 13.8 volts DC (13.6 VDC for FT-720RVH) under load.

Check the transmitter power output as follows:

- a) Connect a suitable dummy load/wattmeter to the antenna jack.
- b) Set the channel selector to any channel. Close the push-to-talk switch, and observe the power output. For the FT-720RV/FT-720RU, the output should be at least 10 watts, while the FT-720RVH should provide at least 25 watts output.

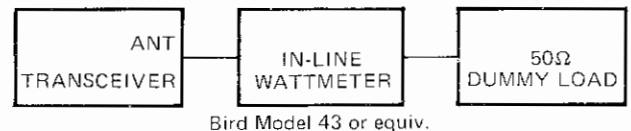

PO TEST SETUP

Check the receiver sensitivity as follows:

- a) Connect an audio voltmeter to the SP jack, and set the squelch control fully counter-clockwise.
- b) Connect the RF output of a precision VHF/UHF signal generator to the antenna jack, and note the audio voltmeter reading with no signal present. Adjust the volume control and voltmeter range, as necessary, to obtain roughly a full-scale reading.
- c) Set the signal generator to the receiving frequency of the radio, and adjust the output amplitude of the signal generator until the voltmeter indicates a 20 dB decrease (1/10th voltage) of the reading in step b). The signal generator output voltage at this point is the 20 dB quieting sensitivity, and it should be approximately 0.32 μ V. (0.5 μ V for FT-720RU)



RX SENSITIVITY TEST SETUP

If the above checks are both OK, then clean out the transceiver by applying moderate-force compressed air throughout the chassis area. This will remove any dust that may be present. If there is accumulated dirt inside the cabinet, a soft brush may be used to loosen it. Wipe the outer cabinet of the transceiver with a damp cloth, and use the compressed air to dislodge accumulated dust present in the corners of the radio.

Note: When a signal level from a signal generator is specified, e.g. "+80 dB," the reference 0 dB = 1 μ V should be used. At 50 ohms, 0 dB (μ V) = -107 dBm.

RECEIVER SECTION

(1) Second Local Oscillator

- a) Connect the RF probe of a VTVM to the base of Q_{1006} . Check to see that the local signal is present (typical value 50–150 mV RMS).
- b) Connect a frequency counter to the emitter of Q_{1005} . Check to see that the frequency of the circuit is correct: 10.245 MHz for FT-720RV, 16.445 MHz for FT-720RU.

(2) First Local Oscillator

- a) Temporarily connect the base of Q_{1005} to ground with a clip lead, in order to disable the second local oscillator.
- b) Connect an IF sweep generator to gate 1 of Q_{1003} , and connect an oscilloscope to the emitter of Q_{1006} .

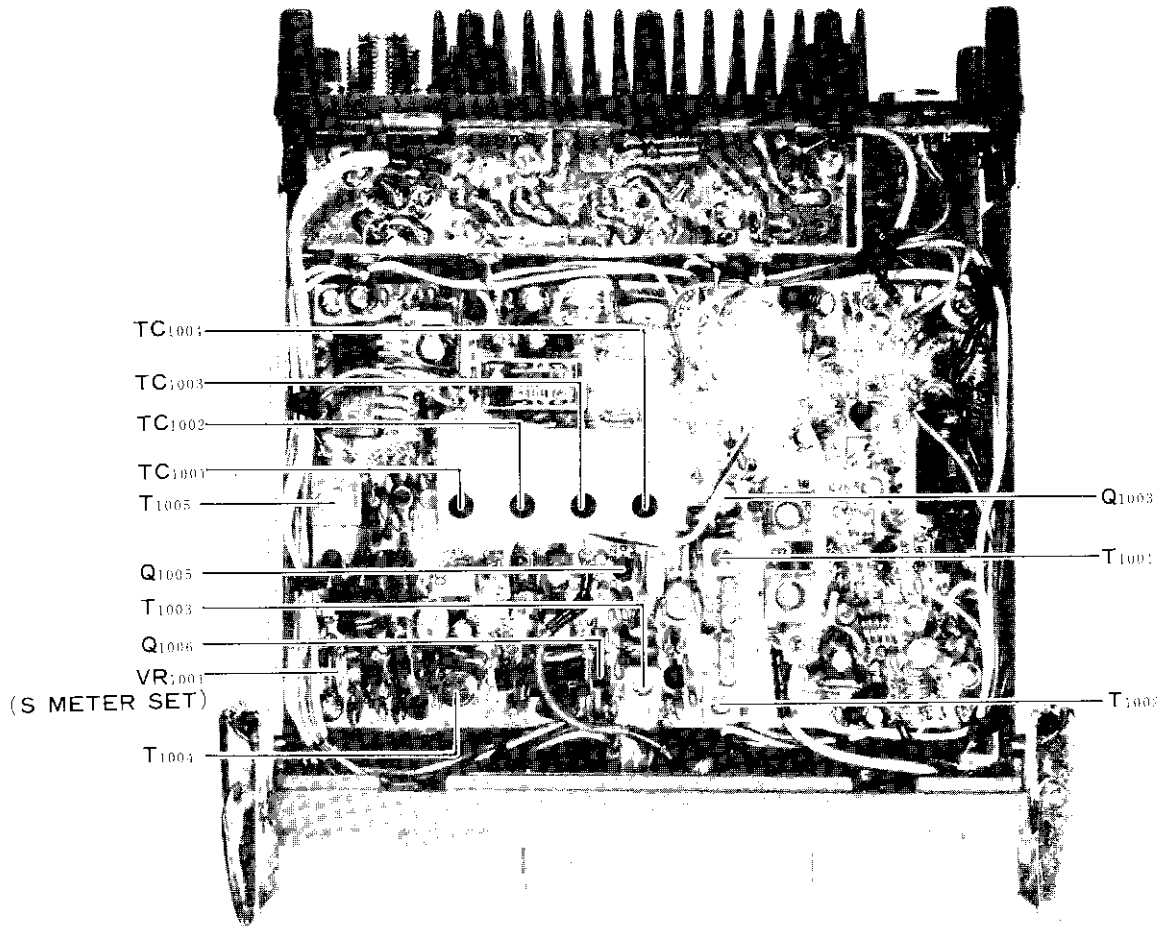

720RV RECEIVER SECTION ALIGNMENT POINTS

- c) Adjust the core of T_{1003} for maximum deflection on the scope, then adjust T_{1001} and T_{1002} so that the display shown in Figure 1 is obtained. Remove the clip lead connected to the base of Q_{1005} .

(3) First Local Helical Resonator Adjustment (FT-720RU)

- a) Connect an RF sweep generator to the LOCAL IN terminal on the RF Unit. Set the sweep output to 428 MHz. Connect an oscilloscope to the source of Q_{1003} .
- b) Adjust TC_{1003} , TC_{1004} , and CV_{1003} for the pattern shown in Figure 2.

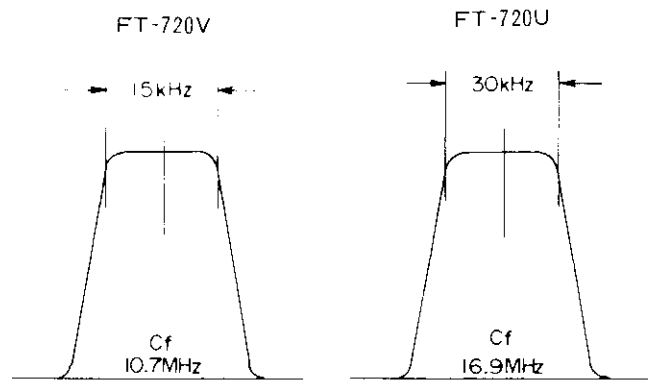

Figure 1

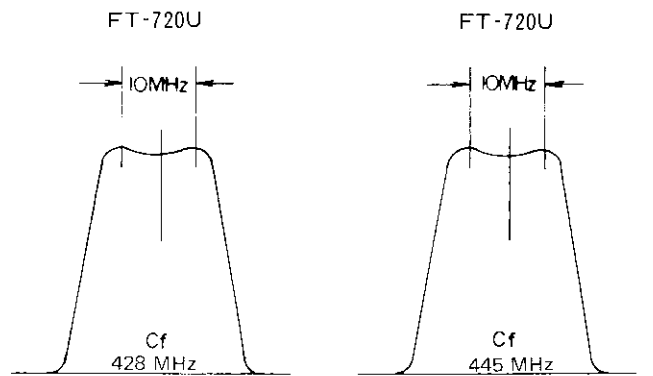
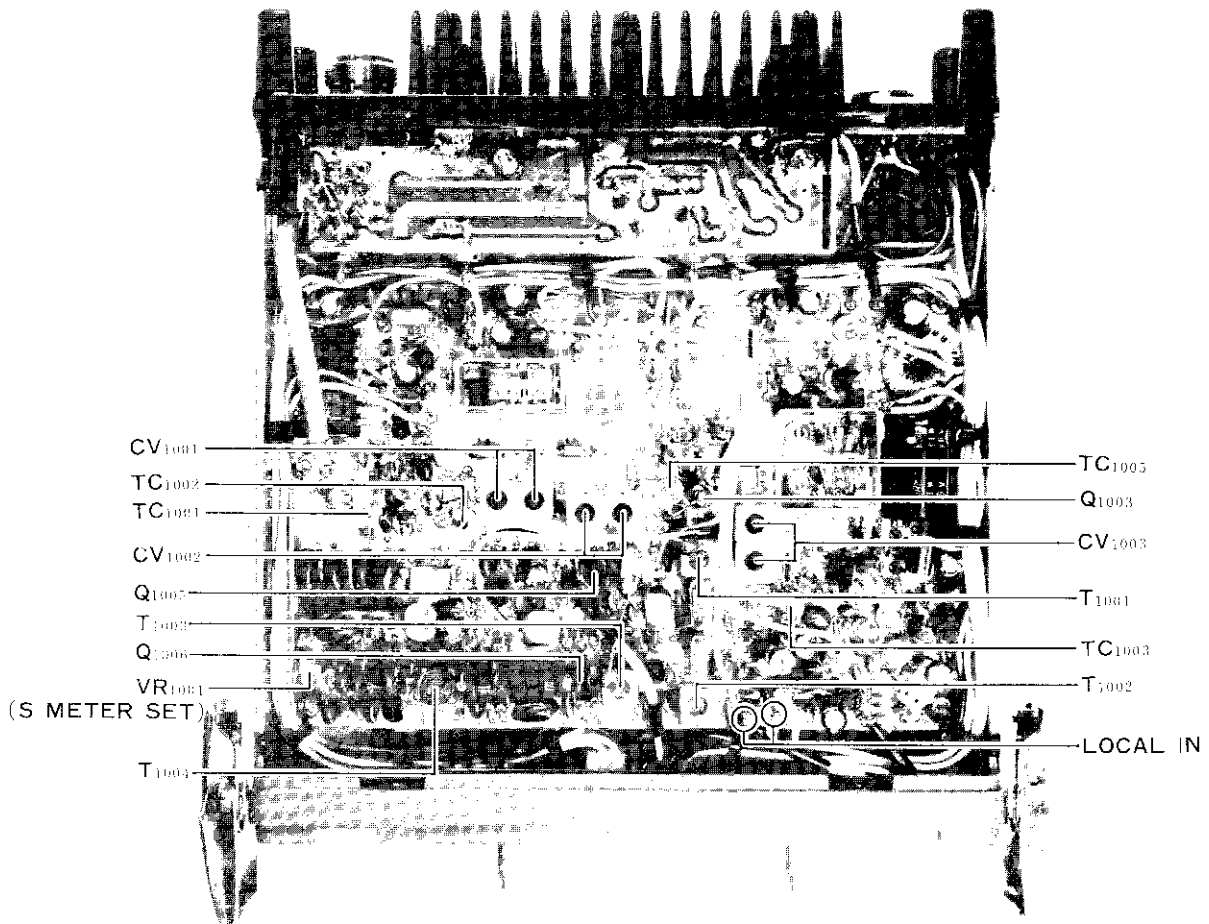
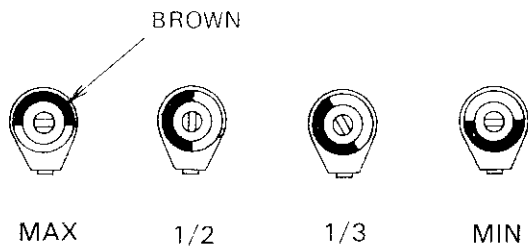

Figure 2

Figure 3



720RU RECEIVER SECTION ALIGNMENT POINTS

(4) RF Helical Resonator Adjustment (FT-720RU)

- a) Connect an RF sweep generator to the antenna jack. Set its output to 445 MHz. Leave the scope connected to the source of Q_{1003} as in the previous section.
- b) Adjust TC_{1001} , TC_{1002} , TC_{1005} , CV_{1001} , and CV_{1002} for the pattern shown in Figure 3.
- c) Repeat the alignment of the first local helical resonator, detailed in section 3, then recheck the RF helical resonator adjustment. The adjustments are interrelated, and several passes may be required to get the desired bandpass characteristics.

(5) RF Bandpass Filter Adjustment (FT-720RV)/ Second IF Alignment

- a) Connect a signal generator to the antenna jack. Set its output to the frequency shown at the beginning of this section (145 MHz, 147 MHz, 435 MHz, or 445 MHz).

- b) Apply a 10 dB signal from the generator, and adjust $TC_{1001} - TC_{1004}$ and T_{1004} (** T_{1003} / T_{1004}) for maximum indication on the front panel S-meter (LED).

(6) S-Meter Full Scale Setting

- a) Increase the signal generator output to +20 dB. Adjust VR_{1001} so that all the LEDs on the S-meter scale are illuminated. With the signal generator switched off, be certain that no LEDs are illuminated.

(7) Squelch Adjustment

- a) Set the signal generator output again to 0 dB.
- b) Set the front panel SQL control fully clockwise. Adjust VR_{5101} , located on the PLL Unit, so that the noise squelch just opens.
- c) Turn off the signal generator. Back off the SQL control very slightly so that the receiver is just muted. Now apply a signal from the signal generator. A signal of approximately -12 dB should be required to trip the squelch.

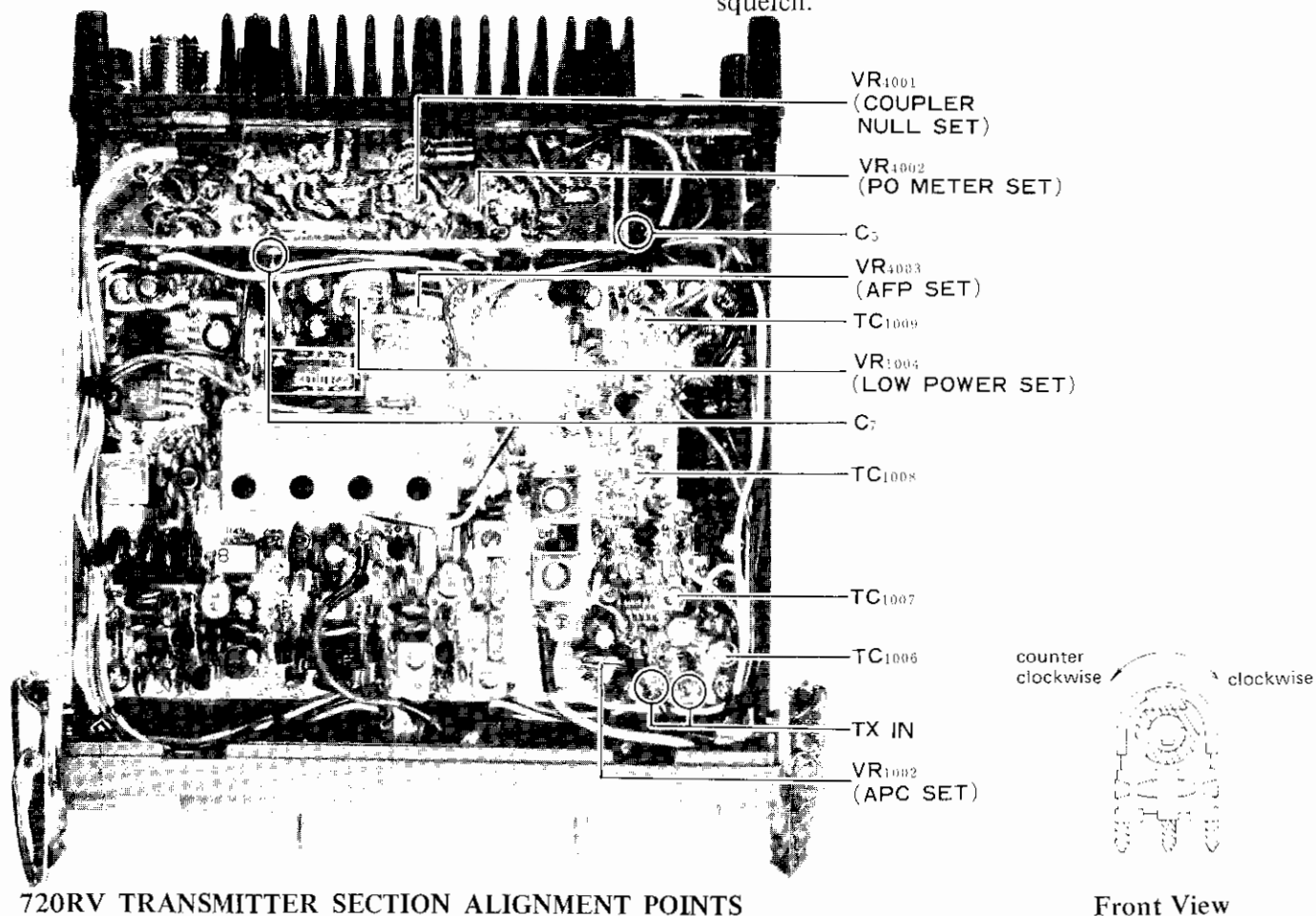

720RV TRANSMITTER SECTION ALIGNMENT POINTS

Front View

TRANSMITTER SECTION

Unless otherwise indicated, always perform the transmitter alignment with a dummy load/wattmeter connected to the antenna jack. If the AFP circuits are being aligned, an improper load impedance at a critical time could result in the destruction of the final transistors.

(1) TX Strip Trimmer Adjustment

- a) With the dummy load/wattmeter connected to the antenna jack, advance VR₁₀₀₂ and VR₁₀₀₃ fully clockwise. Now adjust TC₁₀₀₆ – TC₁₀₀₉ (**TC₁₀₀₆–TC₁₀₁₀) for maximum power output as indicated on the wattmeter.

(2) AFP/PO Meter Adjustment

- a) Connect the DC probe (high impedance) of a VTVM to the hot side of C₄₀₀₇, located on the BOOSTER Unit. Adjust VR₄₀₀₁ for minimum indication on the VTVM.
- b) Connect the VTVM ammeter to the line from feedthru capacitor C₅ (**C₄), and set the

VTVM ammeter for a 5 amp (maximum) scale. Rotate VR₁₀₀₃ fully counterclockwise. Remove the dummy load from the antenna jack, and close the PTT switch. Adjust VR₁₀₀₃ for a reading of 1.5 amperes on the ammeter.

- c) Reconnect the dummy load removed in step b), and transmit. Adjust VR₁₀₀₂ for a power output of 10 watts (25 watts for FT-720RVH).
- d) Now adjust VR₄₀₀₂, located on the BOOSTER Unit, so that nine of the LEDs on the PO scale are illuminated at the power level stipulated in step c).

(3) Deviation Adjustment

- a) Refer to figure 4, and set up the transceiver and test equipment as shown.
- b) Set VR₅₅₀₁, located on the MIC AMP Unit, to the center of its range, and apply a 1 kHz, 25 mV signal from the audio oscillator to the mic jack. Now adjust VR₂₀₀₁, located on the PLL Unit, for a deviation of ±5 kHz (**±12

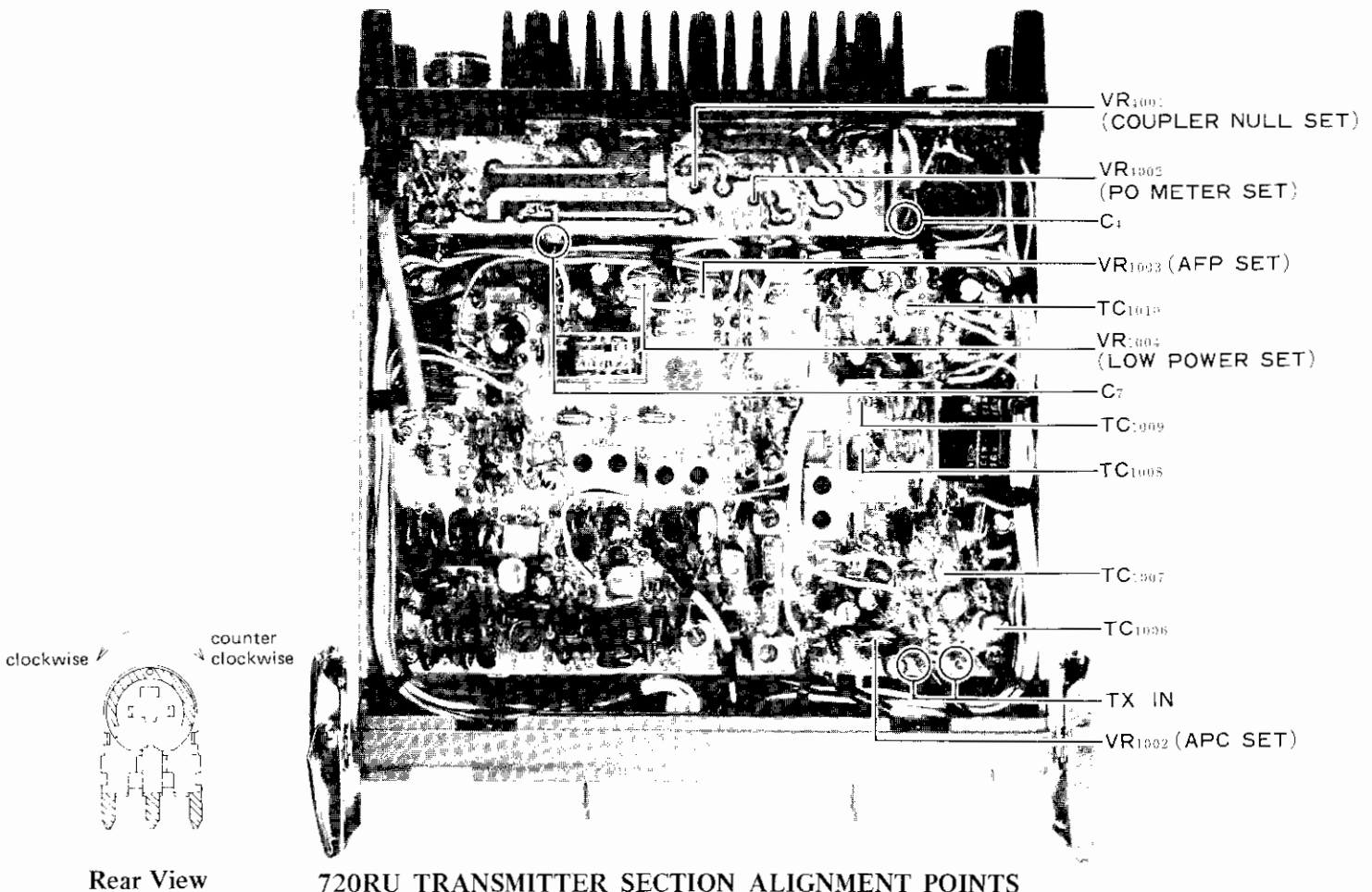

kHz). While performing this adjustment, observe the signal waveform on the scope.

- c) Now reduce the audio generator level to 2.5 mV, and adjust VR₅₅₀₁ for a deviation of ±3.5 kHz (**±8.4 kHz).

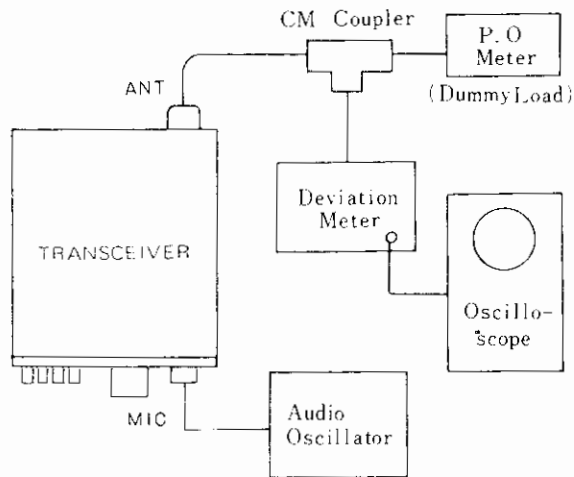

Figure 4

PLL ALIGNMENT

The PLL circuit is very critical in its adjustment. Alignment must only be performed by an experienced technician. All alignments should be performed at a temperature within the range 15° – 30°C, preferably near the center of this range.

1. PLL Reference Oscillator

Connect a frequency counter to TP₂₀₀₂. Adjust TC₂₀₀₁ for a reading of 1800 kHz on the counter.

2. PLL IF Circuit

Connect an oscilloscope to TP₂₀₀₁, and adjust the core of T₂₀₀₂ for maximum deflection of the scope. A typical reading is 300 mV p-p.

3. VCV Line Adjustments

- a) Connect the DC probe of the VTVM to TP₂₀₀₃, and set the channel selector to the low band edge, 143.90 MHz or 144.00 MHz (**set to the high edge, 449.975 MHz or 439.975 MHz). Now adjust L₃₀₀₄ (**TC₃₀₀₂) for a reading of exactly 2.5 volts (**6.5 volts) on the VTVM while transmitting.

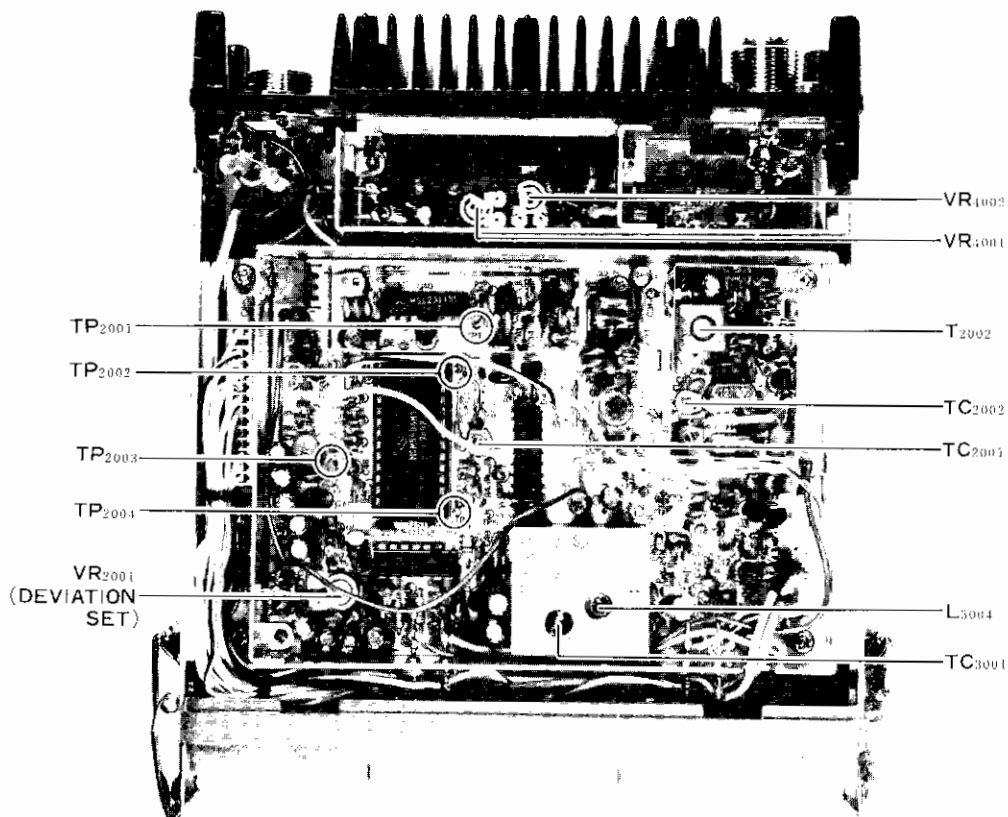

720RV PLL SECTION ALIGNMENT POINTS

b) Connect the DC probe of the VTVM to TP₂₀₀₄. Do not change the channel frequency. Adjust TC₃₀₀₁ on receive for a reading of exactly 3 volts (**6.5 volts) on the VTVM. Recheck the results on transmit, then check the results on receive. The adjustments are interrelated, and several passes may be necessary.

c) Connect the DC probe of the VTVM to TP₂₀₀₃, and rotate the channel selector to the high band edge (**low band edge). Close the PTT switch, and check to see that the voltage is at least 7 volts (**at least 2 volts). Connect the DC probe to TP₂₀₀₄, and do not change the channel frequency. Check the voltage on receive; it should be at least 7 volts (**at least 2 volts).

4. PLL Local Alignment

a) Connect a frequency counter to the TX IN terminal of the RF Unit. Set the repeater shift switch to SIMP. Set the channel selector for the FT-720RV to 145.00 MHz, and close the

PTT switch. Adjust TC₂₀₀₂ for a reading of exactly 145.000 MHz on the counter. Press the 5UP switch, again close the PTT switch, and adjust TC₂₀₀₃ for a reading of exactly 145.005 MHz on the counter.

b) For the FT-720RU, 430–440 MHz model, set the channel selector to the high band edge. Close the PTT switch, and adjust TC₂₀₀₂ for a reading of 219.9875 MHz on the counter. For the 440–450 MHz model, set the channel selector to the high band edge, close the PTT switch, and adjust TC₂₀₀₂ for a reading of 224.9875 MHz on the counter.

c) Connect the frequency counter to the RX LOCAL IN terminal. Set the channel selector to the low band edge. For the 430–440 MHz model, check to see that the frequency is exactly 206.550 MHz. For the 440–450 MHz model, the correct frequency is 211.550 MHz. For the FT-720RV, the correct reading is 133.300 MHz (133.2 MHz at 143.900 MHz). If the readings are not correct, please repeat the PLL Local Alignment procedure.

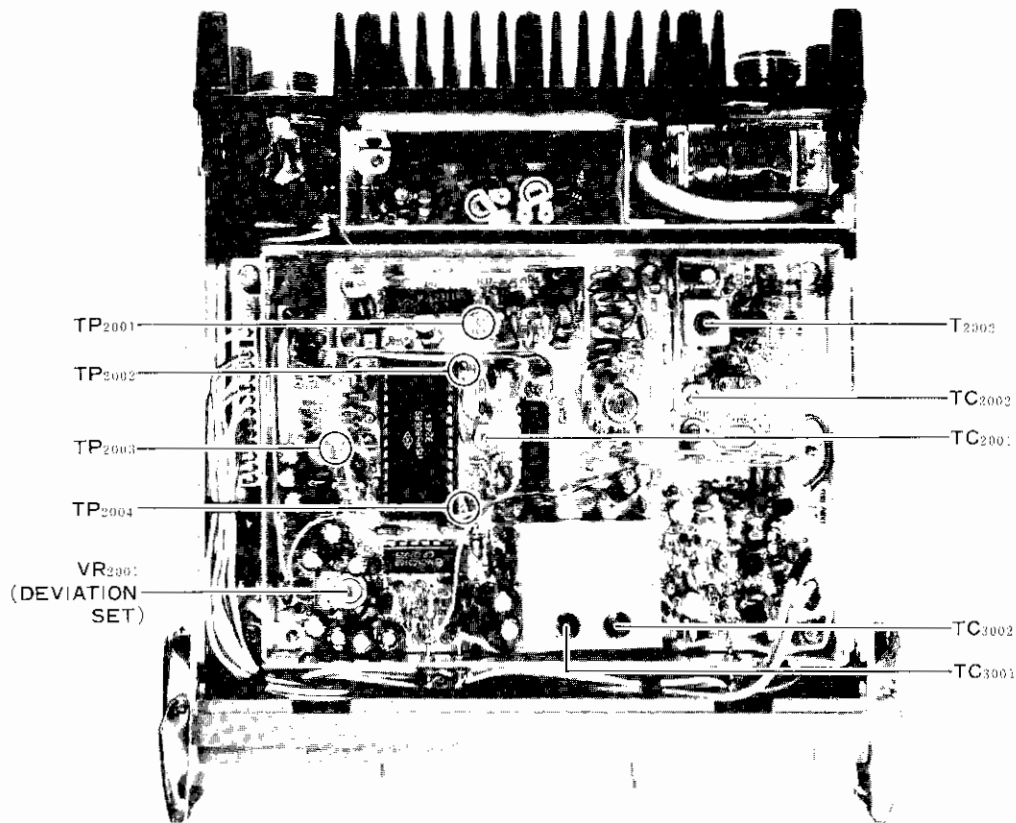

720RU PLL SECTION ALIGNMENT POINTS

PARTS LIST

FT-720R CONTROLLER UNIT

CONTROLLER MAIN CHASSIS					DIODE	
Symbol No.	Parts No.	Description				
			D5112,5113	G2001880F	Germanium	1S188FM
		TRANSISTOR	D5101~5111,	G2015550	Silicon	1S1555
Q5001	G3309450P	2SC945P	5114,5115,			
			5122~5126			
			D5116~5120	G2090123	LED	SR632D
		RESISTOR				
R5001	J01245223	Carbon film 1/4W 22k Ω				
			Q55101	P3090036		IC SOCKET
						40PIN DIP
		POTENTIOMETER				
VR5001 (with S5001)	J62800042	10k Ω A/B AF/SQ				
						CRYSTAL
			X5101	H0101840	HC-18/U	2.56MHz
		CAPACITOR				RESISTOR
C5002,5003	K00175470	Ceramic disk 50WV SL 47pF	R5144	J00245100	Carbon film 1/4W	10 Ω
C5001	K40109003	Electrolytic 10WV 330 μ F	R5116,5126	J00245221	" " "	220 Ω
			R5127,5140	J00245561	" " "	560 Ω
			R5120	J00245102	" " "	1k Ω
			R5114	J00245152	" " "	1.5k Ω
		SPEAKER	R5133	J00245222	" " "	2.2k Ω
SP5001	M4090029	SM50A 8 Ω 1W	R5101,5102,	J00245332	" " "	3.3k Ω
			5110,5112,			
			5125			
		SWITCH				
S5003	N0190058	SRU-1023N	R5119	J00245472	" " "	4.7k Ω
S5005,5007	N6090010	SSF-22-55	R5113,5117	J00245562	" " "	5.6k Ω
S5006	N6090011	SSH-23-05	R5115,5121,	J00245103	" " "	10k Ω
S5002 (with Rotary Encoder)	N0190052 Q9000073	SRS1016 Z99W-04	5129,5134,			
			5136,5149,			
			5140			
			R5118	J00245183	" " "	18k Ω
			R5103,5104,	J00245223	" " "	22k Ω
		RECEPTACLE	5107,5122,			
J5001	P1090087	SR30-10R-6S	5128,5132,			
J5002	P1090005	SG8050	5143,5146			
J5003	P0090037	5048-08A	R5148	J01245223	" " "	22k Ω
			R5137,5139,	J00245473	" " "	47k Ω
			5147			
		PLUG				
P5001	P0090116	P-1628BA-ST	R5141	J00245563	" " "	56k Ω
P5002	T9202360	5247-08 with Wire	R5142	J00245823	" " "	82k Ω
			R5105,5106,	J00245104	" " "	100k Ω
			5108,5109,			
			5111,5138			
			R5123,5124	J00245154	" " "	150k Ω
			R5130	J00245105	" " "	1M Ω
			R5135	J00245225	" " "	2.2M Ω
			R5131	J00245335	" " "	3.3M Ω
		PLL CONT UNIT				
Symbol No.	Parts No.	Description				
PB-2070B	F0002070B	Printed Circuit Board				
	C0020700	PCB with components				
		TRANSISTOR & IC				
Q5104,5105, 5108,5109, 5112~5115	G3309450P	Tr 2SC945P	RB5101	J40900012	1/16W 56k Ω x9	BLOCK RESISTOR
Q5106,5107, 5110	G3318150G	" 2SC1815GR	RB5102	J40900011	" 10k Ω x6	
Q5101	G3090005	" MPS-A13	RB5103	J40900010	" 10k Ω x4	
Q5102	G1090231	IC MSM5841-12RS				
Q5111	G1090068	" MC14011B	TH5101	G9090001		THERMISTOR
Q5103	G1090050	" MC14519B				SDT-250
						POTENTIOMETER
			VR5101	J50714103		10k Ω B

<http://www.foxtango.org>

FT-720R CONTROLLER UNIT

		CAPACITOR		R5203,5204	J00245102	Carbon film	1/4W	1kΩ
C5102,5103	K00175560	Ceramic disk	50WV SL	56pF	R5205~5209	J00245393	" " "	39kΩ
C5133	K00175101	" " "	" "	100pF	R5210,5212,	J00245104	" " "	100kΩ
C5113,5127, 5128,5130	K12171102	" " "	" "	0.001μF	5214,5216, 5218,5220, 5222			
C5104	K14179002	" " "	" "	0.01μF				
C5109,5126	K50177472	Mylar	" "	0.0047μF				
C5108,5110, 5111,5114, 5120,5121, 5131	K50177103	" " "	" "	0.01μF				
CAPACITOR								
C5204	K14170103	Ceramic disk	50WV	0.01μF				
C5203,5205	K40109001	Electrolytic	10WV	100μF				
C5201,5202	K40129001	" "	16WV	330μF				
C5119,5125	K70167104	Tantalum	35WV	0.1μF				
C5101	K70167224	" " "	" "	0.22μF				
C5112,5115, 5129	K70167474	" " "	" "	0.47μF				
C5106	K70167105	" " "	" "	1μF	P5201	P1090043		3024-13C
C5116	K70127475	" " "	16WV	4.7μF				
C5105,5107, 5132	K71137685	" " "	20WV	6.8μF				
C5118,5123	K40170105	Electrolytic	50WV	1μF				
C5117	K40149001	" " "	25WV	4.7μF	P5101 (with Wire)	T9202370		5247-13
C5122,5124	K40109002	" " "	10WV	47μF				
PLUG								
MINICONNECTOR								
		INDUCTOR		LED UNIT				
L5101,5102	L1190017	FL-5H102K,	1mH		Symbol No.	Parts No.	Description	
				PB-2072	F0002072	Printed Circuit Board		
					C0020720	PCB with components		
SWITCH								
S5101,5102, 5105	N4090022		SPJ222T48					
S5103,5104	N4090023		SPJ222T49		Q5301~5304	G3107190Q	Tr	2SA719Q
					Q5305	G1090241	IC	TA7612AP
MINI CONNECTOR								
J5101	P0090039		5048-13A					
DIODE								
				D5301	G2090124	LED	SG232D	
				D5302	G2090123	" "	SR632D	
Q5000020				Wrapping Terminal, MS60121	D5303~5309	G2090116	" "	LN422YP
Q5000026				TP-F	D5310~5312	G2090070	" "	LN222RP
DRIVER UNIT								
Symbol No.	Parts No.	Description		LED DISPLAY				
PB-2071	F0002071	Printed Circuit Board		DS5301 (USA MODEL)	G2090117	LN543RA		
	C0020710	PCB with components		DS5301 (EU MODEL)	G2090120	LN543RAH3		
TRANSISTOR								
Q5214	G3107190Q	2SA719Q						
Q5202~5205, 5213	G3309450P	2SC945P			P1090135	3024-12C		
Q5201	G3402350Y	2SD235Y						
Q5206~5212	G3408920R	2SD892R						
RESISTOR								
R5211,5213, 5215,5217, 5219,5221, 5223	J00245220	Carbon film	1/4W	22Ω	R5309,5310, 5314,5315	J00245221	Carbon film	1/4W 220Ω
					R5303,5311, 5312,5313	J01245221	" " "	220Ω
D5201	G2090113	Zener	HZ-6B2		R5302	J00245561	" " "	560Ω
					R5304	J01245561	" " "	560Ω
					R5301, 5316~5318	J00245821	" " "	820Ω
					R5307	J00245102	" " "	1kΩ
					R5308	J00245103	" " "	10kΩ
					R5306	J00245473	" " "	47kΩ
R5201,5202	J20335330	Metallic film	2W	33Ω	R5305	J00245104	" " "	100kΩ

FT-720R CONTROLLER UNIT

		CAPACITOR					TRANSISTOR	
C5301	K12171102	Ceramic	50WV	0.001 μ F	Q5502	G3309450P	2SC945P	
					Q5501	G3318150	2SC1815	
		MINICONNECTOR						
	P0090044			3022-13A			RESISTOR	
					R5507,5509	J00245101	Carbon film	1/4W 100 Ω
					R5502	J00245221	" "	" 220 Ω
					R5508	J00245472	" "	" 4.7k Ω
					R5504	J00245682	" "	" 6.8k Ω
					R5505	J00245103	" "	" 10k Ω
					R5503	J00245223	" "	" 22k Ω
					R5506	J00245333	" "	" 33k Ω
					R5501	J00245474	" "	" 470k Ω
AF AMP UNIT								
Symbol No.	Parts No.	Description						
PB-2073	F0002073	Printed Circuit Board						
	G0020730	PCB with components						
		IC						
Q5401	G1090073			μ PC575C2				
Q5402	G1090239			TC5082P			POTENTIOMETER	
					VR5501	J50716502	RV8-FAS	5k Ω B
		CRYSTAL						
X5401 (USA MODEL)	H0100601	HC-25/U		3.6864MHz			CAPACITOR	
X5401 (EU MODEL)	H0100602	"		3.584MHz	C5509	K00175101	Ceramic	50WV SL 100pF
					C5501,5502, 5505	K12171102	" "	" 0.001 μ F
					C5503	K50177682	Mylar	" 0.0068 μ F
					C5507	K70167104	Tantalum	35WV 0.1 μ F
		CRYSTAL SOCKET			C5504	K70127106	"	16WV 10 μ F
	P1090138			1-380758-0	C5506	K40129004	Electrolytic	16WV 10 μ F
					C5508	K40109001	"	10WV 100 μ F
		RESISTOR						
R5404	J00245221	Carbon film	1/4W	220 Ω		L9190001	Ferrite Beads	
R5401	J00245473	" "	"	47k Ω				
R5403	J00245124	" "	"	120k Ω				
R5402	J00245154	" "	"	150k Ω		Q5000016	TP-E	
R5405	J00245224	" "	"	220k Ω				
							SWITCH UNIT	
		POTENTIOMETER			Symbol No.	Parts No.	Description	
VR5401	J51730103	P6-S3NA		10k Ω B	PB-2075B	F0002075B	Printed Circuit Board	
						C0020750B	PCB with components	
		CAPACITOR						
C5415	K00175150	Ceramic	50WV SL	15pF			IC	
C5409,5410	K00175330	" "	" "	33pF	Q5601	G1090068	MC14011B	
C5416	K00175101	" "	" "	100pF				
C5404,5412	K12171102	" "	" "	0.001 μ F				
C5413,5414	K50177103	Mylar	"	0.01 μ F			RESISTOR	
C5406	K50177104	" "	" "	0.1 μ F	R5601	J00245273	Carbon film	1/4W 27k Ω
C5402	K40149001	Electrolytic	25WV	4.7 μ F	R5602	J00245224	" "	" 220k Ω
C5403	K40129002	"	16WV	47 μ F				
C5407	K40109001	"	10WV	100 μ F				
C5408	K40129001	"	16WV	330 μ F			CAPACITOR	
C5401,5411	K70167104	Tantalum	35WV	0.1 μ F	C5601	K00175101	Ceramic	50WV SL 100pF
C5405	K70127476	"	10WV	47 μ F	C5602	K71137685	Tantalum	20WV 6.8 μ F
	Q5000016			TP-E				
MIC AMP UNIT								
Symbol No.	Parts No.	Description						
PB-2074	F0002074	Printed Circuit Board						
	C0020740	PCB with components						

720RV MAIN UNIT

MAIN CHASSIS					
Symbol No.	Parts No.	Description			CRYSTAL FILTER
		DIODE	XF1001	H1102013	FMT-15B
D01	G2090034	Silicon U05B			
		CAPACITOR	CF1001	H3900202	CERAMIC FILTER CFW455F
C09	K00175150	Ceramic disk 50WV SL 15pF			
C01,02	K12171102	" " " 0.001μF			
C03~08	K21170002	Feed thru " 0.001μF			
			CD1001	H7900040	CERAMIC DISCRIMINATOR SFD455S4
		INDUCTOR			
L01	L0020334				RESISTOR
			R1068	J00245100	Carbon film 1/4W 10Ω
			R1006,1010, 1021,1022, 1046,1055, 1057	J00245560	" " " 56Ω
			R1026,1027, 1041,1053, 1065	J00245101	" " " 100Ω
		RECEPTACLE			
J01	P0090010	FM-142S			
J02	P1090026	S0-239	R1030,1067	J00245221	" " " 220Ω
J03	P1090136	S-1628A-STA	R1043,1045, 1047	J00245471	" " " 470Ω
J04	P1090173	EMCS0450M			
PB-2132	F0002132	J04 Connector board	R1033,1038, 1064,1074, 1077	J00245102	" " " 1kΩ
		MINI CONNECTOR			
P01(with Wire)	T9202350A	5047-13	R1025,1034, 1048,1069, 1075	J00245222	" " " 2.2kΩ
		RF UNIT			
Symbol No.	Parts No.	Description			
PB-2077	F0002077	Printed Circuit Board	R1002,1035	J00245272	" " " 2.7kΩ
	C0020770	PCB with components	R1052	J00245332	" " " 3.3kΩ
			R1020	J00245392	" " " 3.9kΩ
			R1073	J00245472	" " " 4.7kΩ
			R1049,1050, 1063,1072	J00245562	" " " 5.6kΩ
		TRANSISTOR, FET & IC			
Q1021	G31049600	Tr 2SA4960	R1024,1029, 1032,1036	J00245682	" " " 6.8kΩ
Q1006,1007	G3304600B	" 2SC460B			
Q1015	G3305352	" 2SC535B	R1056,1061, 1062,1071,	J00245103	" " " 10kΩ
Q1005,1008, 1009,1011, 1013,1014, 1019,1020	G3309450P	" 2SC945P		J00245123	" " " 12kΩ
Q1004	G3316740	" 2SC1674	R1003,1005, 1023,1031, 1037,1040, 1054,1059	J00245223	" " " 22kΩ
Q1016	G3320530	" 2SC2053			
Q1022	G34023500	" 2SD2350	R1001,1015, 1016,1040	J00245473	" " " 47kΩ
Q1001	G4800480	FET 3SK48			
Q1003,1012	G4800510C	" 3SK51-03	R1018,1042, 1044,1058,	J00245104	" " " 100kΩ
Q1010	G1090072	IC μPC577H			
Q1017	G1090084	" μPC78L05	R1051	J00245334	" " " 330kΩ
Q1018	G1090070	" μPC14308	R1028	J00245684	" " " 680kΩ
		DIODE	TH1001	G9090013	THERMISTOR 25D29
D1001~1004	G2001880F	Germanium 1S188FM			
D1005~1011	G2015550	Silicon 1S1555			
			VR1004	J50716502	POTENTIOMETER RV8-FAS 5kΩ
		CRYSTAL	V1002,1003	J50716103	" 10kΩ
X1001	H0100720	HC-18/C 10.245MHz	V1001	J50716503	" 50kΩ

720RV MAIN UNIT

		CAPACITOR				TRIMMER CAPACITOR	
C1018	K02172020	Ceramic disk	50WV CH	2pF	TC1002~1004, 1006~1009	K91000028	ECV1ZW10x53, 10pF
C1001,1019, 1027	K02172030	" "	" "	3pF	TC1001	K91000029	" 20x53, 20pF
C1037	K00172050	" "	"	SL 5pF			
C1009,1011, 1013,1017, 1080	K02172050	" "	"	CH 5pF			
C1032	K00173100	" "	"	SL 10pF	L1016	L1190005	FL4H1R0M, 1μH
C1007,1008, 1079,1086	K02173100	" "	"	CH 10pF	L1001	L1190008	FL4H2R2M, 2.2μH
C1074,1118	K02175120	" "	" "	12pF	L1011	L1190106	EL0810-220K, 22μH
C1028	K00175150	" "	"	SL 15pF	L1012,1013	L1190107	EL0810-222K, 2.2mH
C1010,1012	K02175180	" "	"	CH 18pF	L1002(R1008),	L1020469	
C1014,1075, 1087	K02179009	" "	" "	22pF	L1050(R1009),		
C1002,1033	K00175470	" "	"	SL 47pF	L1020(R1066),		
C1054	K00175101	" "	" "	100pF	L1025(R1070),		
C1034,1035	K00175151	" "	" "	150pF	L1026(R1076)		
C1003~1006, 1015,1016, 1020,1021, 1023,1024, 1046,1049, 1052, 1063~1068, 1070,1071, 1073, 1976~1078, 1082~1084, 1089,1094, 1096~1101, 1103~1105, 1107,1108, 1111, 1114~1117, 1119	K12171102	" "	"	0.001μF	L1014,1018, 1023	L0020471	
C1022,1025, 1026, 1029~1031, 1036,1038, 1085	K14170103	" "	"	0.01μF	L1015	L0020772	
C1040	K14170473	" "	"	0.047μF	L1017,1019	L0020472	
C1041,1045	K50177102	Mylar	"	0.001μF	L1024	L0020474	
C1047,1050, 1051,1059	K50177103	"	"	0.01μF	L1003	L0020302	
C1048	K50177223	"	"	0.022μF			
C1039,1043, 1053, 1055~1058	K50177473	"	"	0.047μF			
C1069	K40170105	Electrolytic	"	1μF			
C1102	K40140475	"	25WV	4.7μF			
C1044,1061, 1072,1081, 1088,1106, 1113	K40120106	"	16WV	10μF			
C1091	K40120226	"	"	22μF			
C1095	K40109002	"	"	47μF			
C1112	K40100107	"	10WV	100μF			
C1092	K40129003	"	16WV	1000μF			
C1060	K70167104	Tantalum	35WV	0.1μF			
C1052,1093, 1109,1110	K70167474	"	"	0.47μF			
C1062	K70167105	"	"	1μF			
					INDUCTOR		
					TRANSFORMER		
					CHOKE		
					RELAY		
					FERRITE BEADS		
					WRAPPING TERMINAL C		
					PLL UNIT		
					TRANSISTOR, FET & IC		
					PRINTED CIRCUIT BOARD		
					PLL & 2m VCO		
					with components		
					TR		
					IC		

720RV MAIN UNIT

Q2016	G1090244	IC	MC14528B	R2038,2061, 2064,2065, 2071,2073, 2089	J00245103	Carbon film 1/4W	10kΩ
Q2022	G1090065	"	μPC14305				
		DIODE		R2044	J01245103	" " "	680kΩ
D2001,2002, 2010, 2011 (USA MODEL)	G2090027	Silicon	1SS53	R2088	J00245123	" " "	12kΩ
				R2030	J00245183	" " "	18kΩ
D2003~2009	G2015550	"	1S1555	R2010,2011, 2042,2060, 2076,2077, 2093,2096 (USA MODEL)	J00245223	" " "	22kΩ
		IC SOCKET		R2054,2057, 2063	J00245333	" " "	33kΩ
QS2001	P3090035		116-28-30-114	R2039	J01245393	" " "	39kΩ
				R2002~2004, 2015~2017, 2045	J00245473	" " "	47kΩ
		CRYSTAL		R2051~2053	J01245473	" " "	47kΩ
X2001 (USA MODEL)	H0101620	HC-43/U	7.2MHz	R2035	J00245683	" " "	68kΩ
X2001 (EU MODEL)	H0101630	"	3.6MHz	R2072	J01245823	" " "	TJ 82kΩ
X2002	H0101670	"	127.300MHz	R2062,2084 (USA MODEL)	J00245104	" " "	100kΩ
X2003 (USA MODEL)	H0101680	"	127.305MHz	R2066 (EU MODEL)			
				R2074	J00245184	" " "	180kΩ
		RESISTOR		R2058,2075, 2080	J00245224	" " "	220kΩ
R2026,2086	J00245560	Carbon film	1/4W 56Ω	R2067	J00245274	" " "	270kΩ
R2005,2018, 2033	J00245680	" "	" 68Ω	R2059	J00245684	" " "	680kΩ
R2001,2020, 2021,2023, 2024,2029, 2037,2069, 2079	J00245101	" " "	" 100Ω				
						POTENTIOMETER	
R2034,2082	J00245221	" " "	" 220Ω	VR2001	J51729103	RV8-FAN	10kΩ
R2062,2084 (EU MODEL)	J00245471	" " "	" 470Ω				
R2066 (USA MODEL)	J00245471	" " "	" 470Ω			CAPACITOR	
R2070,2083	J00245561	" " "	" 560Ω	C2022,2026	K00179001	Ceramic disk 50WV SL	0.5pF
R2027	J00245821	" " "	" 820Ω	C2001,2007	K00172050	" " " "	5pF
R2009,2014, 2022,2032, 2036,2041, 2105 (USA MODEL)	J00245102	" " "	" 1kΩ	C2087,2089 (USA MODEL)	K06172050	" " " "	UJ 5pF
				C2078	K02173080	" " " "	CH 8pF
				C2077	K00173100	" " " "	SL 10pF
				C2010,2011, 2020,2021	K00175180	" " " "	18pF
R2028,2040, 2087	J00245152	" " "	" 1.5kΩ	C2045	K02179009	" " " "	CH 22pF
				C2044	K02179013	" " " "	33pF
R2007,2008, 2013,2047, 2055,2056, 2081, 2097~2104, 2095 (USA MODEL)	J00245222	" " "	" 2.2kΩ	C2082	K06175330	" " " "	UJ 33pF
				C2083	K06175680	" " " "	68pF
				C2034	K00175101	" " " "	SL 100pF
				C2002, 2004~2006, 2008,2009, 2012, 2014~2019, 2023~2025, 2028,2032, 2036,2079, 2081	K12171102	" " " "	0.001μF
R2050,2068	J00245272	" " "	" 2.7kΩ	C2027, 2029~2031, 2033,2035, 2037~2042,	K14170103	" " " "	0.01μF
R2031,2046, 2078,2106	J00245472	" " "	" 4.7kΩ				
R2043,2048, 2091,2092, 2094 (USA MODEL)	J00245562	" " "	" 5.6kΩ				
R2049	J01245562	" " "	" 5.6kΩ				
R2012,2025	J00245103	" " "	" 10kΩ				

720RV TRANSCEIVER MAIN UNIT

C2046,2060, 2074,2076, 2084,2086, 2099	K14170103	Ceramic disk	50WV	0.01 μ F		Q5000011	Wrapping terminal C
C2088,2090, 2091 (USA MODEL)						L9190001	Ferrite Beads
2m VCO BOARD							
C2092~2096	K21170002	Feed thru	"	0.001 μ F	Symbol No.	Parts No.	Description
C2097,2098 (USA MODEL)					PB-2078	F0002078	Printed Circuit Board
C2066	K50177102	Mylar	"	0.001 μ F		C0020780	PCB with components
C2065	K50177472	"	"	0.0047 μ F			
C2013,2050, 2051,2056, 2058	K50177103	"	"	0.01 μ F			FET
C2052,2054	K50177223	"	"	0.022 μ F	Q3001	G3800190G	2SK19GR
C2053,2055, 2061,2063, 2064,2068, 2069	K40170105	Electrolytic	"	1 μ F			DIODE
C2003,2062, 2067,2070, 2071,2075, 2080	K40120106	"	16WV	10 μ F	D3001	G2090027	Silicon 1SS53
C2047,2073	K70167474	Tantalum	25WV	0.47 μ F	D3002	G2090107	Varactor 1T25
C2057	K70147105	"	35WV	1 μ F	D3003	G2090108	" 1SV68
C2049	K70127475	"	16WV	4.7 μ F			RESISTOR
C2043	K71137685	"	20WV	6.8 μ F	R3005	J00245101	Carbon film 1/4W 100 Ω
C2048,2059	K70127106	"	16WV	10 μ F	R3006	J00245331	" " " 330 Ω
					R3001~3004	J00245104	" " " 100k Ω
							THERMISTOR
					TH3001	G9090008	31D26
							CAPACITOR
		TRIMMER CAPACITOR			C3008	K02179001	Ceramic disk 50WV CH1pF
TC2001,2002	K91000029	ECV-1ZW20x53N, 20pF			C3009	K02172040	" " " " 4pF
TC2003 (USA MODEL)					C3006	K06173070	" " " UJ 7pF
					C3004	K02173100	" " " CH 10pF
					C3013	K06173100	" " " UJ 10pF
					C3014	K06175180	" " " " 18pF
		INDUCTOR			C3003	K02179009	" " " CH 22pF
L2008	L1190010	FL4H3R9K, 3.9 μ H			C3001,3002, 3005,3007, 3010,3012, 3016	K12171102	" " " " 0.001 μ F
L2006	L1190023	FL5H220K, 22 μ H					
L2007,2010	L1190016	FL5H101K, 100 μ H					
L2009	L1190001	EL0710251K, 250 μ H					
L2001,2015 (USA MODEL)	L1190017	FL5H102K, 1mH			C3011	K70127475	Tantalum 16WV 4.7 μ F
L2011	L1190035	FL7H392J, 3.9mH			C3015	K70127106	" " 10 μ F
L2002(R2002), 2005(R2019).	L1020004						TRIMMER CAPACITOR
L2003,2004	L0020749				TC3001	K91000071	TZ03Z200A, 20pF
L2012(R2085)	L1020469						
L2013	L0020205						INDUCTOR
L2014(R2090)	L1020253				L3005	L1190108	FL3HR68M, 0.68 μ H
					L3001~3003	L1190105	FL3H1R0M, 1 μ H
					L3004	L0190015	
		TRANSFORMER					
T2001	L0020209						
T2002	L0020750					Q5000020	Wrapping terminal MS60121
		RECEPTACLE			2m BOOSTER UNIT		
J2001	P0090039	5248-13A			Symbol No.	Parts No.	Description
					PB-2079	F0002079	Printed Circuit Board
						C0020790	2m BOOSTER UNIT
	Q5000020	Wrapping terminal MS60121					

720RV MAIN UNIT

		POWER MODULE	FT-720RV ACCESSORIES		
			Symbol No.	Parts No.	Description
Q4001 (10W MODEL)	G1090251	M57715		M3090022	Microphone assembly YM-32
Q4001 (25W MODEL)	G1090252	M57712		P0090115	" plug FM10PS-6H
				T9006705	Power cord assembly (10W MODEL)
		DIODE		P1090019	Power plug FM142P
D4001	G2090001	Silicon 10D1		Q2000001	Fuse holder SN1101
D4002,4004	G2001880F	Germanium 1S188FM		Q0000005	Fuse 5A
D4003	G2015550	Silicon 1S1555			
				T9006710	Power cord assembly (25W MODEL)
		RESISTOR		P1090019	Power plug FM142P
R4005	J01245101	Carbon film 1/4W 100 Ω		Q2000001	Fuse holder SN1101
R4003	J01245222	" " " 2.2k Ω		Q0000007	Fuse 10A
R4004	J01245473	" " " 47k Ω			
				Q0000005	Fuse 5A (10W MODEL)
				Q0000007	" 10A (25W MODEL)
		POTENTIOMETER			
VR4001	J51729201	RV8-FAN 200 Ω			
VR4002	J51729503	" 50k Ω		P0090034	External speaker plug P-2240
		CAPACITOR		R0058530	Stand
C4009	K00172030	Ceramic disk 50WV SL 3pF			
C4019,4021 (25W MODEL)	K00172030	" " " " 3pF			Mobile Bracket Assembly with Set screws
C4020 (25W MODEL)	K00172050	" " " " 5pF			
C4006~4008, 4014,4015	K00175150	" " " " 15pF			TONE IN PLUG
C4016	K00175270	" " " " 27pF		P0090174	ENCHUM 0401W (with contact)
C4002,4004, 4005,4011, 4012	K12171102	" " " " 0.001 μ F			
C4010	K14179002	" " " " 0.01 μ F			
C4001,4003, 4017	K40120106	Electrolytic 16WV 10 μ F			
		INDUCTOR			
L4001(R4001), L4002(R4002)	L1020663				
L4003,4004, 4006	L0020679				
L4005	L0020776				
		RELAY			
RL4001	M1190006	BR221-D012			

<http://www.foxtango.org>

720RU MAIN UNIT

MAIN CHASSIS					CRYSTAL FILTER
Symbol No.	Parts No.	Description	XF1001	H1102014	16M20B
		DIODE			CERAMIC FILTER
D01	G2090034	Silicon U05B	CF1001	H3900200	CFW455E
					HELICAL RESONATOR
		CAPACITOR	CV1001,1002		
C01,02	K12171102	Ceramic 50WV 0.001 μ F	(USA MODEL)	Q9000063	7HW-1004
C03~08	K21170002	Feed thru " 0.001 μ F	(EU MODEL)	Q9000064	7HW-1006
			CV1003		
			(USA MODEL)	Q9000066	7HW-1008
			(EU MODEL)	Q9000065	7HW-1007
		RELAY			
RL01(with J02)	M1590001	CX140A			
			CD1001	H7900040	CERAMIC DISCRIMINATOR SFD455S4
		SWITCH			
S01	N6090004	SSF-22-08			RESISTOR
			R1057,1065, 1068	J00245100	Carbon film 1/4W 10 Ω
		RECEPTACLE	R1078	J01245330	" " " 33 Ω
J01	P0090010	FM-142S	R1006,1016, 1021,1022, 1046	J00245560	" " " 56 Ω
J03	P1090136	S-1628A-STA			
			R1026,1027, 1041,1053, 1067	J00245101	" " " 100 Ω
		PLUG			
P01(with Wire)	T9202350A	S047-13			
			R1013,1030	J00245221	" " " 220 Ω
			R1043,1045, 1047	J00245471	" " " 470 Ω
			R1039	J00245561	" " " 560 Ω
			R1064	J00245681	" " " 680 Ω
			R1012,1033, 1038,1074	J00245102	" " " 1k Ω
			R1034	J00245152	" " " 1.5k Ω
		TRANSISTOR, FET & IC	R1025,1035, 1048,1069, 1075	J00245222	" " " 2.2k Ω
Q1021	G31049600	Tr 2SA4960			
Q1006,1007	G3304600B	" 2SC460B			
Q1005,1008, 1009,1011, 1013,1014, 1019,1020	G3309450P	" 2SC945P	R1029,1052	J00245332	" " " 3.3k Ω
			R1019,1073, 1079	J00245472	" " " 4.7k Ω
Q1004	G3316740	" 2SC1674	R1011,1049, 1050,1063	J00245562	" " " 5.6k Ω
Q1002	G3320260	" 2SC2026			
Q1015,1016	G3324070	" 2SC2407	R1024,1032, 1036	J00245682	" " " 6.8k Ω
Q1022	G34023500	" 2SD2350			
Q1012	G4800510C	FET 3SK51-03	R1002,1056, 1061,1062, 1071,1072	J00245103	" " " 10k Ω
Q1001	G4800700	" 3SK70			
Q1003	G4800920	" 3SK92	R1020	J00245123	" " " 12k Ω
Q1010	G1090072	IC μ PC577H	R1001,1004, 1005,1015, 1023,1031, 1037,1040, 1054,1059	J00245223	" " " 22k Ω
Q1017	G1090084	" μ PC78L05			
Q1018	G1090070	" μ PC14308			
			R1003,1017, 1018,1042, 1044,1051, 1058,1076	J00245104	" " " 100k Ω
		DIODE			
D1001~1004	G2001880F	Germanium 1S188FM			
D1005~1010	G2015550	Silicon 1S1555			
			R1028	J00245334	" " " 330k Ω
		CRYSTAL			
X1001 (USA MODEL)	H0101610	HC-18/U 17.355MHz			
X1001 (EU MODEL)	H0101600	" 16.445MHz			

720RU MAIN UNIT

		POTENTIOMETER	C1060	K70167104	Tantalum 35WV 0.1 μ F
VR1004	J50714502	5k Ω B	C1052,1093,	K70167474	Tantalum 35WV 0.47 μ F
VR1002,1003	J50714103	10k Ω B	1109,1110		
VR1001	J50714503	50k Ω B	C1062	K70167105	" " 1 μ F
		CAPACITOR			
C1001,1009, I027,1079	K02172020	Ceramic disk 50WV CH2pF			
C1017,1082, I083	K02172030	" " " " 3pF			
C1007,1074, I081	K02172040	" " " " 4pF	TC1002	K91000059	TRIMMER CAPACITOR ECV-1ZW04x53, 4pF
C1015	K02173060	" " " " 6pF	TC1001,1003, 1005,1006, 1008~1010	K91000055	ECV-1ZW06x53, 6pF
C1120,1121	K02173070	" " " " 7pF			
C1037	K00173100	" " " SL 10pF	TC1007	K91000028	ECV-1ZW10x53, 10pF
C1028,1032	K00175150	" " " " 15pF			
C1075	K02175150	" " " CH 15pF			
C1006,1014, I033	K00175470	" " " SL 47pF			INDUCTOR
C1021,1022, I054	K00175101	" " " " 100pF	L1007,1016	L1190005	FL-4H1ROM, 1 μ H
C1034,1035	K00175121	" " " " 120pF	L1011	L1190106	FL-4H220K, 22 μ H
C1119	K10179018	" " " " 680pF	L1012,1013	L1190107	FL-4H222K, 2.2mH
C1002~1005, I008, I011,1012, I019,1020, I023,1024, I046,1049, I063~1068, I070,1071, I073,1076, I077, I085~1087, I090,1094, I096~1101, I103~1105, I107,1108, I111, I114~1116, I122	K12171102	" " " " 0.001 μ F	L1001,1003, 1008,1010	L0020523	
			L1002(R1007),	L1020005	RFC
			L1006(R1014)		
			L1004(R1008),	L1020469	"
			L1005(R1009),		
			L1020(R1066),		
			L1025(R1070)		
			L1014,1015, I021,1022	L0020471	
			L1017,1024	L0020474	
			L1018,1023	L0020472	
			L1026	L0020584	
					TRANSFORMER
			T1001~1003	L0020637	16.9MHz
			T1004	L0190002	7MC-312162NO
					CHOKE COIL
C1025,1026, I029~1031, I036,1038,	K14170103	" " " 0.01 μ F	CH1001	L2030067	FR14/7/5-2001F
C1013,1016, I118	K14179002	" " " 0.01 μ F			RELAY
C1040	K14170473	" " " 0.047 μ F	RL1001	M1190002	FBR221-D012
C1078,1088	K23140001	" chip 25WV 0.01 μ F			
C1041,1045	K50177102	Mylar 50WV 0.001 μ F		L9190001	Ferrite Bead
C1042,1047, I050,1051, I059	K50177103	" " 0.01 μ F		Q5000011	Wrapping terminal C
				Q5000020	" " MS60121
				Q5000016	TP-E
C1048	K50177223	" " 0.022 μ F			
C1039,1043, I053, I055~1058	K50177473	" " 0.047 μ F			
PLL UNIT					
			Symbol No.	Parts No.	Description
C1069	K40170105	Electrolytic 50WV 1 μ F	PB-2067	F0002067	Printed Circuit Board
C1102	K40149001	" 25WV 4.7 μ F		C0020670	PLL & 70cm VCO
C1044,1061, I072,1084, I089,1106, I113	K40129004	" 16WV 10 μ F			with components
					TRANSISTOR, FET & IC
C1091	K40120226	" " 22 μ F	Q2008,2009	G3305352	Tr 2SC535B
C1095	K40109002	" 10WV 47 μ F	Q2003,2004, 2011,2014, 2015,2017	G3309450P	" 2SC945P
C1112	K40109001	" " 100 μ F			
C1092	K40129003	" 16WV 1000 μ F			

720RU MAIN UNIT

C2058	K50177103	Mylar	50WV	0.01 μ F			DIODE
C2052,2054	K50177223	"	"	0.022 μ F	D3001	G2090027	Silicon 1SS53
	K70167104	Tantalum	35WV	0.1 μ F	D3002	G2090107	Varactor 1T25
C2047,2073	K70167474	"	"	0.47 μ F	D3003	G2090108	" 1SV68
C2057	K70147105	"	25WV	1.0 μ F			
C2049	K70167475	"	35WV	4.7 μ F			
C2043	K71137685	"	20WV	6.8 μ F			RESISTOR
C2048,2059,2072	K70127106	"	16WV	10 μ F	R3005	J00245101	Carbon film 1/4W 100 Ω
					R3006	J00245331	" " " 330 Ω
C2053,2055,2061,2063,2064,2068,2069	K40170105	Electrolytic	50WV	1 μ F	R3001~3004	J00245104	" " " 100k Ω
							THERMISTOR
C2003,2062,2067,2070,2071,2075,2080	K40129004	"	16WV	10 μ F	TH3001	G9090008	31D26
							CAPACITOR
					C3007,3008	K02179001	Ceramic 50WV CH 1pF
					C3003	K02173080	" " " 8pF
					C3006,3012	K02173100	" " " 10pF
					C3004	K02173100	" " " 10pF
		TRIMMER CAPACITOR			(USA MODEL)		
TC2001,2002	K91000029	ECV1ZW20x53N, 20pF			C3004	K02175120	" " " 12pF
					(EU MODEL)		
					C3013	K06175180	" " LJ 18pF
		INDUCTOR			C3001,3002,3005,3009,3011,3015	K12171102	" " 0.001 μ F
L2008	L1190010	FL4H3R9K, 3.9 μ H			C3010	K70127475	Tantalum 16WV 4.7 μ F
L2006	L1190023	FL5H220K, 22 μ H			C3014	K70127106	" " 10 μ F
L2007,2010	L1190016	FL5H101K, 100 μ H					
L2009	L1190001	EL0710251K, 250 μ H					
L2001	L1190017	FL5H102K, 1mH					
L2011	L1190035	FL7H392J, 3.9mH					
L2002(R2006), 2005(R2019)	L1020004	RFC					TRIMMER CAPACITOR
					TC3001,3002	K91000056	TZ03Z070A, 7pF
L2012(R2085)	L1020469	"					
L2014(R2090)	L1020253	"					
L2013	L0020205						INDUCTOR
L2003,2004	L0020584				L3005	L1190108	FL3HR68M, 0.68 μ H
					L3001~3003	L1190105	FL3HIR0M, 1 μ H
					L3004	L0020359A	S6-B
		TRANSFORMER					
T2001	L0020209						
T2002	L0020510					Q5000020	Wrapping terminal, MS-60121
		RECEPTACLE					
J2001	P0090039	5048-13A			70cm BOOSTER UNIT		
				Symbol No.	Parts No.	Description	
				Q5000020	F0002069	Printed Circuit Board	
				Q5000011	C0020690	PCB with components	
	L9190001	Ferrite Beads				POWER MODULE	
				Q4001	G1090225	M57704M	
70cm VCO BOARD							
Symbol No.	Parts No.	Description				DIODE	
PB-2068	F0002068	Printed Circuit Board				D4003	G2001880F
	C0020680	PCB with components				D4002	G2015550
					D4001,4004,4005	G2090118	Schottky Barrier 1SS97
		FET			D4006	G2090001	Silicon 10D1
Q3001	G3800190G	2SK19GR					RESISTOR
					R4003	J01245360	Carbon film 1/4W 56 Ω

720RU MAIN UNIT

		POTENTIOMETER	FT-720RU ACCESSORIES		
Symbol No.	Parts No.	Description			
VR4001,4002	J51729201	RV8-FAN 200Ω			
			M3090022		Microphone assembly YM-32
			P0090115		" plug FM10PS-6H
		CAPACITOR			
C4016	K02172010	Ceramic disk 50WV CH1pF			
C4008~4010	K02172040	" " " CH4pF	T9006705		Power cord assembly
C4006,4007	K02173060	" " " " 6pF	P1090019		Power plug FM142P
C4005	K02173070	" " " " 7pF	Q2000001		Fuse holder SN1101
C4011~4013, 4015	K12171102	" " " " 0.001μF	Q0000005		Fuse 5A
C4002,4004	K14170103	" " " " 0.01μF			
C4001,4003	K40129004	Electrolytic 16WV 10μF	Q0000005		Fuse 5A
		INDUCTOR			
L4001(R4001), L4002(R4002)	L1020469		P0090034		External speaker plug P-2240
L4003	L0020767				
L4007,4008	L0020677		R0058530		Stand
					Mobile Bracket Assembly with Set screws
					TONE IN PLUG
			P0090174		EMCHUM 0401W

<http://www.foxtango.org>

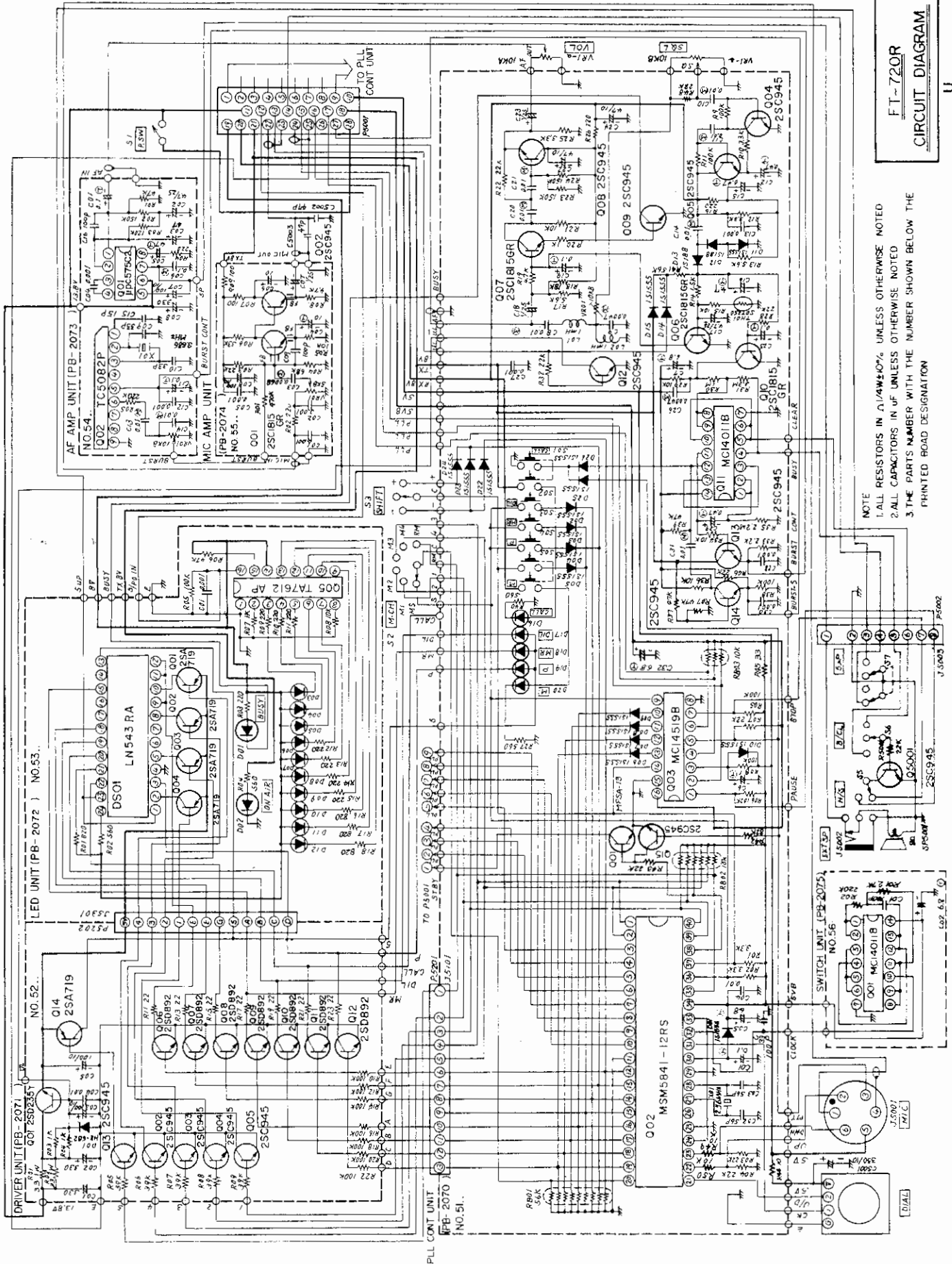

NOTE
 1 ALL RESISTORS IN $\frac{1}{4}$ W/5% UNLESS OTHERWISE NOTED
 2 ALL CAPACITORS IN μ F UNLESS OTHERWISE NOTED
 3 THE PARTS NUMBER WITH THE NUMBER SHOWN BELOW THE PRINTED BOARD DESIGNATION

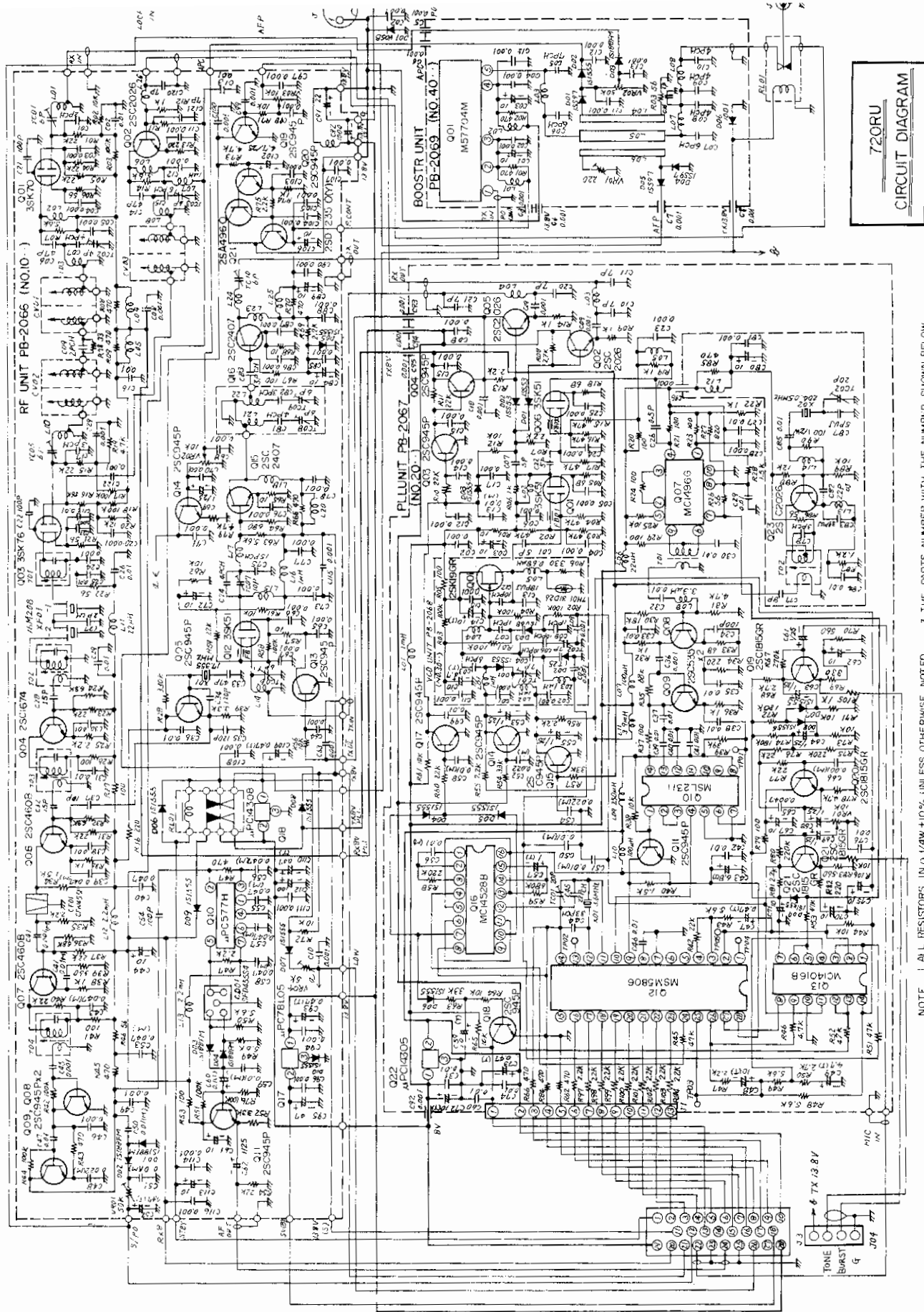

720RU
CIRCUIT DIAGRAM
70U

NOTE 1 ALL RESISTORS IN Ω / μ W $\pm 10\%$ UNLESS OTHERWISE NOTED
 2 ALL CAPACITORS IN μ F UNLESS OTHERWISE NOTED
 3 THE PARTS NUMBER WITH THE NUMBER SHOWN BELOW
 4 THE PRINTED BOARD DESIGNATION

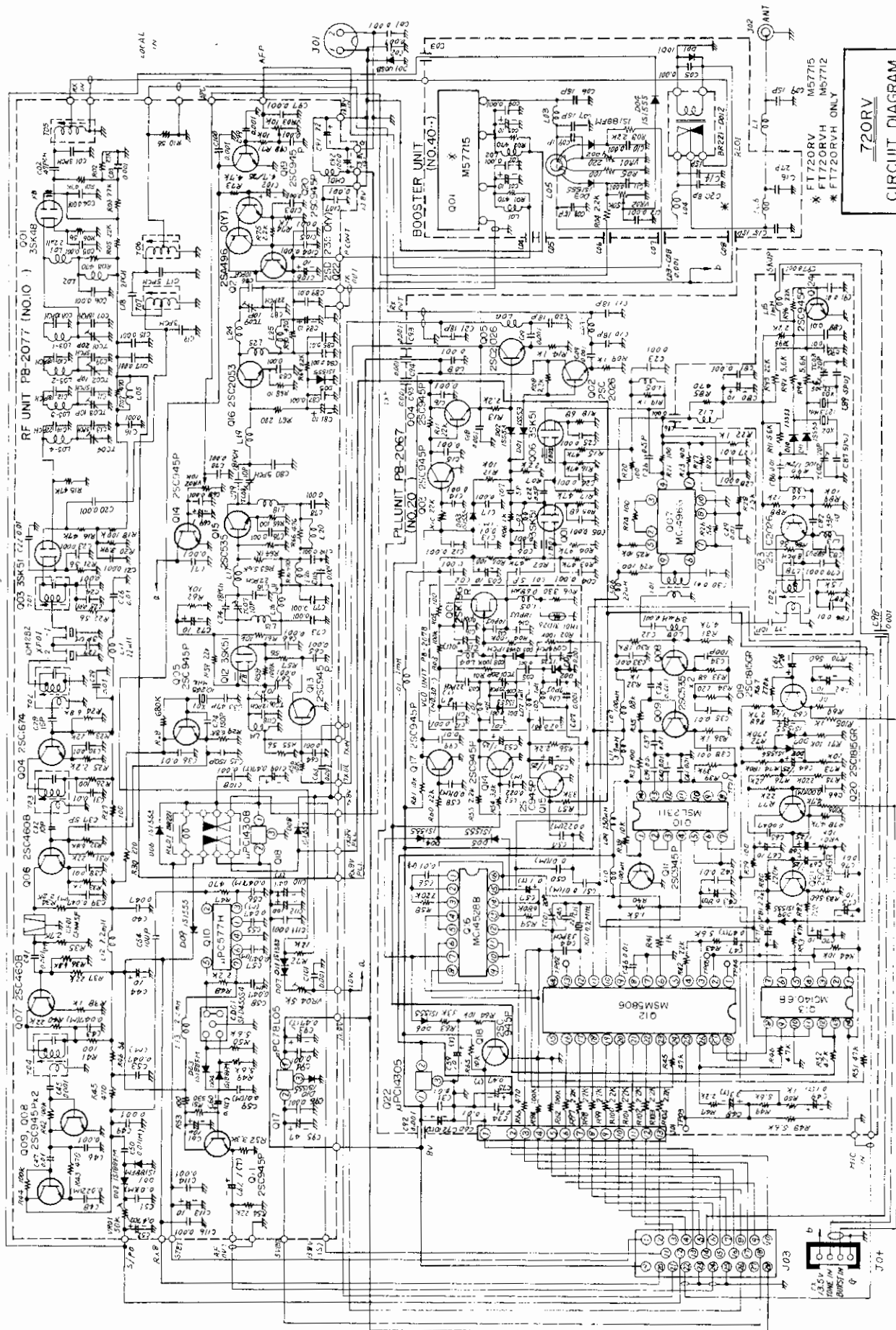

720RV
CIRCUIT DIAGRAM

20U:EU4

NOTE 1 ALL RESISTORS IN Ω , K , M , W , +10\% UNLESS OTHERWISE NOTED
 2 ALL CAPACITORS IN μF UNLESS OTHERWISE NOTED
 3 THE PARTS NUMBER WITH THE NUMBER SHOWN BELOW THE PRINTED BOARD DESIGNATION



FOX TANGO INTERNATIONAL



<http://www.foxtango.org>