

**INSTRUCTION
MANUAL
FV-101DM**

YAESU MUSEN CO., LTD.

C.P.O. BOX 1500
TOKYO, JAPAN

FV-101DM DIGITAL MEMORY VFO FOR FT-101ZD



GENERAL DESCRIPTION

The FV-101DM digital memory VFO enables the owner of the FT-101ZD to enjoy an astounding degree of control over his transmit and receive frequencies on any band selected by the FT-101ZD. Twelve independent memories are instantly accessible, and each can be controlled from either the FT-101ZD Main Tuning Dial or the Keyboard on the front of the FV-101DM; giving the operator essentially 12 separate VFOs. The Keyboard includes a standard numerical configuration for frequency entry, as well as control functions for step scanning in either 5 or 20 kHz steps and independent clarifier operation (over the entire band) for either transmit or receive. In addition to the independent Tuning Dial, the FV-101DM also has pushbutton scanning controls right on the front panel, which can scan the entire band in 10 Hz steps using any of the 12 VFO Channels or the clarifier. Twelve status indicating LEDs let the operator know the operating conditions at a glance.

Four of the memory channels are protected from accidental changing by a separate memory write activating button, allowing semi-permanent storage of favorite frequencies. Each of the remaining eight memory channels can be used to store frequencies tuned on the FT-101ZD with just the touch of a button, so all manner of split operation is a breeze, while the contester can suddenly be present on twelve different frequencies almost at once.

The FV-101DM includes a beep tone generator to indicate keyboard contact, and the frequency display and dial lamp intensity are adjustable from the front panel DIM control. The FV-101DM connects easily to the External VFO connectors on the back of the FT-101ZD, and requires connection to any standard line voltage between 100 and 234 VAC.

The owner is encouraged to study this manual carefully in order to become familiar with the many exciting functions of the FV-101DM, and to be able to fully utilize the vast operating flexibility that the FV-101DM brings to his station.

Please note that the FV-101DM is intended for use only with those FT-101ZD transceivers having serial numbers XX240001 and above.

SPECIFICATIONS

Oscillation frequency:
4.9–5.6 MHz

Frequency steps:
10 Hz

Output voltage:
130 mV rms at 50Ω

Output impedance:
50Ω unbalanced

Frequency stability:
±200 Hz (0°C–50°C)

Number of memory channels:
12 channels (4 channels protected)

Clarifier:
TX/RX 10 Hz steps

Power supply:
100–234 VAC

Power consumption:
22 VA

Dimensions:
W 215 x H 157 x D 320 mm

Weight:
4.5 kg Approx.

Semiconductors:
46 ICs, 3 FETs, 55 TRs, 44 Diodes, 12 LEDs,
5 Display.

ACCESSORIES

1 Connection cable (A) T9101261 1

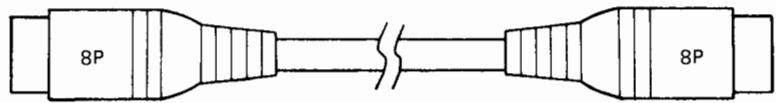

Cable (A)

2 Connection cable (B) T9101260 1

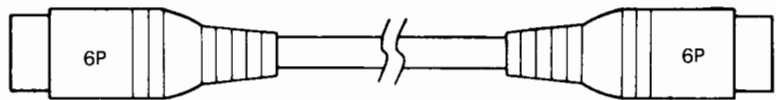

Cable (B)

3 Fuse 1A Q0000002 1

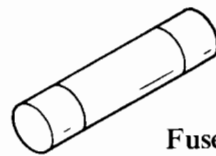

Fuse

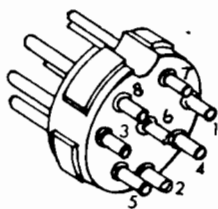

PIN No
1 12V
2 USB 8V
3 VFO 6V
4 +500kHz SHIFT
5 LSB 8V
6 TX EXT
7 D VFO OUT
8 XCVR VFO IN

EXT VFO A

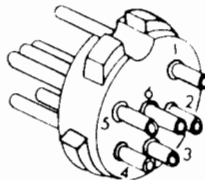

PIN No
1 VFO OUT (FV-101Z, FV-901DM)
2 NC (FV-101DM)
3 GND
4 EXT 6V IN
5 AGC IN (FV-901DM)
6 TX 12V IN
7 GND (FV-101Z, FV-901DM)
8 RX EXT (FV-101DM)

EXT VFO B

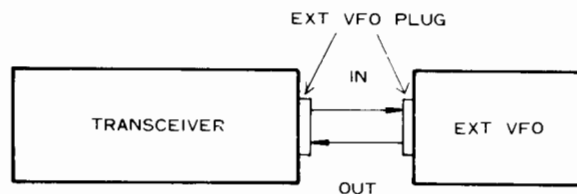

FRONT PANEL CONTROLS AND SWITCHES

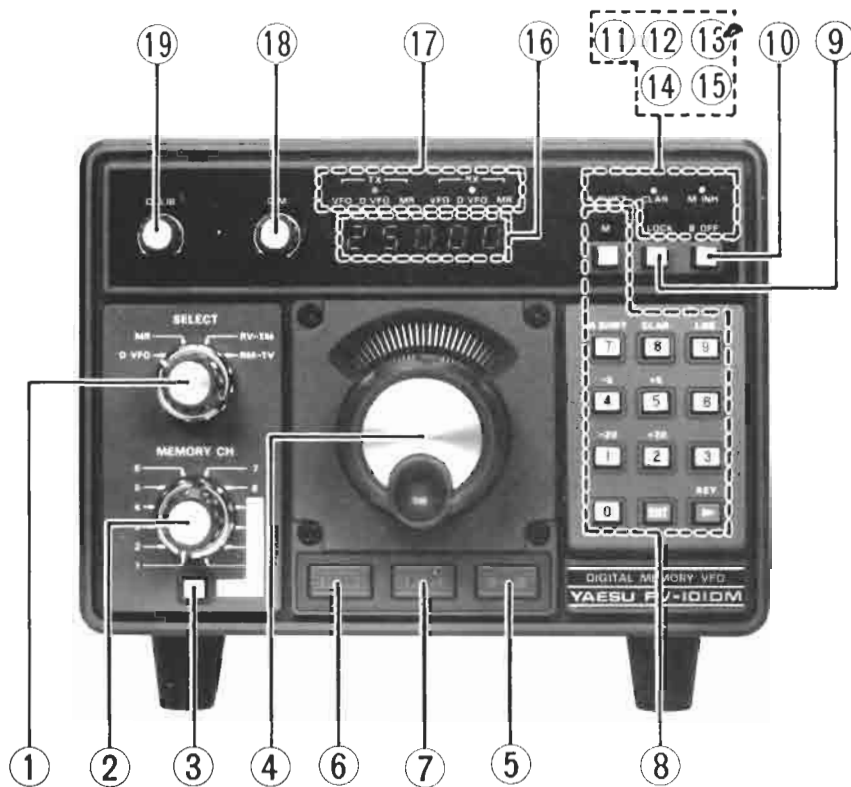

1. SELECT

This switch determines the operating mode of the FV-101DM.

A. D VFO (DIAL VFO)

In the D VFO position, frequency control is via the FV-101DM digital VFO (as opposed to control via the memory).

B. MR (MEMORY READ)

In the MR position, frequency control on both transmit and receive is via the memory system.

C. RV-TM (RECEIVE BY VFO – TRANSMIT MEMORY)

In the RV-TM position, the receiver is controlled by the dial VFO, while the transmitter is controlled by the memory.

D. RM-TV (RECEIVE MEMORY – TRANSMIT VFO)

In the RM-TV position, the receiver is controlled by the memory, while the transmitter is controlled by the dial VFO.

2. MEMORY CH

This switch selects the desired memory channel.

3. MW (MEMORY WRITE)

The MW switch is used for storage of frequencies in memory channels 9 through 12. In order to make some memory channels less prone to inadvertent erasure by the operator, channels 9 through 12 require the pressing of the MW switch as well as the M button for memory storage when the frequency to be stored is entered from the dial, or just the MW switch when the frequency to be stored is entered from the keyboard.

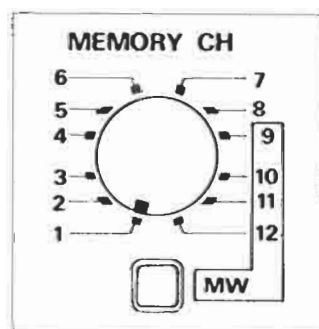

4. DIAL

This is the main tuning dial for the FV-101DM. For smooth, precise tuning, the synthesizer resolution is in 10 Hz steps. After two seconds of continuous rotation in one direction, the synthesizer will automatically program itself for frequency change at twice the normal rate. When much faster QSY is desired, the FAST button may be pressed while the dial is being rotated; this will cause the rate to be increased by a factor of ten.

5. UP

Press this button to select scanning toward a higher frequency.

6. DOWN

Press this button to select scanning toward a lower frequency.

7. FAST

Pressing this button along with either the UP or DOWN scanning buttons will increase the rate of frequency change. The FAST button may also be used to increase the speed of frequency change when using the main tuning dial, as explained previously.

8. KEYBOARD

The keyboard controls the frequency programming of the VFO, along with operating commands for the FV-101DM.

A. 0-9 KEYS

These keys are used for entry of the operating frequency.

B. KEY

This key is used to enable the numerical key functions, and to select the digit which is to be changed or entered.

C. ENT (ENTER)

Press this key after the desired frequency has been set.

D. M SHIFT (MEMORY SHIFT)

This key allows you to shift a frequency stored in memory. When memory operation has been selected, press the M SHIFT to allow frequency change either via the main dial or the UP/DOWN scanning controls. Another press of this switch turns off the memory shift function, returning you to the frequency originally programmed. When using the memory shift, the ± 5 kHz and ± 20 kHz shift keys are not operational.

E. -20, +20, -5, +5 KEYS

These keys are used to program instantaneous frequency shifts of ± 20 kHz or ± 5 kHz from the original operating frequency.

F. CLAR (CLARIFIER)

The clarifier function is activated by this key, for offset of the receive frequency from the main operating frequency. The keyboard and the $\pm 5/20$ kHz shift functions are disabled during clarifier operation.

G. LDB (LAST DIGIT BLANK)

Pushing this key blanks the 10 Hz digit on the digital display. When a frequency is entered from the keyboard, the 10 Hz digit will automatically be displayed

H. M (MEMORIZE)

To enter a frequency from the FT-101ZD Display into a memory channel (channels 1-8), just press this key. For channels 9 through 12, press this key along with the MW button. To zero the FV-101DM frequency to that of the FT-101ZD main dial, set the FT-101ZD VFO Select switch to VFO, set the FV-101DM Select switch to D VFO, and press the M button. Under some conditions (explained below), memory entry may be inhibited.

9. D LOCK (DIAL LOCK)

To disable the main dial and scanning controls (so as to prevent accidental frequency change), press this button.

10. B OFF (BEEPER OFF)

This button disables the warning beeper, which is activated when the frequency is moved outside the normal 0-500 kHz range.

11. M SHIFT Indicator

This indicator is illuminated when the memory shift function is engaged.

12. CLAR Indicator

When the clarifier function is activated, this indicator is illuminated.

13. M INH (MEMORY INHIBIT) Indicator

The memory inhibit indicator lights up when the memories are protected from any changes, or an impossible command is received. The functions involved and solutions are shown below.

- A. Frequency entry via the keyboard is impossible. This may be caused by having the SELECT switch in the MR or RM-TV position, with the MEMORY CH switch set to the CH 9 – 12 positions.

Appropriate action is any of the following:

1. Set the SELECT switch to D VFO.
 2. Set the MEMORY CH switch to any of channels 1 through 8.
 3. Enter a frequency while simultaneously pressing MW.
- B. Storage of a memory frequency is inhibited. This condition would arise if only the M button is pressed when the MEMORY CH selector is set to channel 9–12.

Appropriate action is:

1. If entry of the frequency on a secure channel is desired, channels 9 through 12, press the M and MW buttons simultaneously.
 2. Switch to a non-secure memory channel (1 through 8). In this case, press just M to store the frequency.
- C. Matching the FV-101DM frequency to that of the FT-101ZD is impossible. This error signal would be generated if the FT-101ZD VFO Selector were set to EXT.

Appropriate action is to set the FT-101ZD Selector switch to VFO.

14. D LOCK Indicator

This indicator lights up when the D LOCK function is activated.

15. B OFF Indicator

This indicator lights up when you are tuning outside the normal 0–500 kHz range of the VFO. This indicator will also light up each time a key on the keyboard is pressed.

16. DIGITAL FREQUENCY DISPLAY

The large, five-digit display provides resolution of the operating frequency to 10 Hz.

17. VFO Indicators

These indicators display the operating modes (TX/RX) for the VFO.

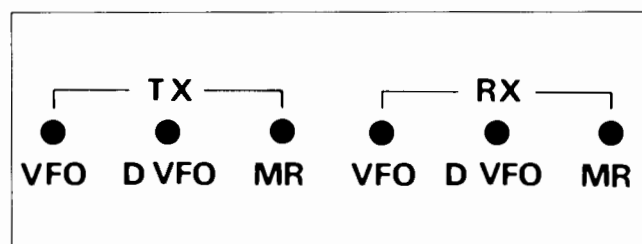

18. DIM

This control adjusts the brightness of the digital display and the main dial illumination, for maximum operator comfort.

19. CALIB

This control allows initial zeroing of the FV-101DM frequency exactly to that of the FT-101ZD.

OPERATION

The operation of the FV-101DM in conjunction with the FT-101ZD adds several dimensions of operating flexibility never before possible with a transceiver/VFO combination. This added flexibility, however, involves somewhat increased complexity in the operating procedure. Until familiarity is gained with the various operating modes of the FV-101DM, the operator is urged to refer to this manual for operating instructions.

A. BASIC OPERATION USING MAIN TUNING DIAL AND SCANNER

11. Preset the controls and switches as follows:
 - a) Set the FT-101ZD SELECT switch to VFO.
 - b) Set the FT-101ZD BAND switch to the desired band (e.g. 20 meters).
 - c) Set the FT-101ZD MODE switch to the desired mode.
 - d) Set the FV-101DM SELECT switch to D VFO.
 - e) Set the FV-101DM MEMORY CH switch to 1.
 - f) Set the FV-101DM DIM knob fully clockwise.
 - g) Set the FV-101DM CALIB control to the 12 o'clock position.
2. Turn the FT-101ZD POWER switch ON. The FV-101DM lamps should become illuminated. Set the FT-101ZD to approximately 14.000 MHz, and switch on the MARK. Tune in the MARK signal for a comfortable beat note (approximately 700 Hz).
3. Set the FT-101ZD SELECT switch to EXT. Now rotate the FV-101DM dial around 14.000 MHz until the MARK signal is heard again. Carefully tune in the MARK signal so that the beat note tuned by the FV-101DM matches that of the one tuned by the FT-101ZD in the VFO position. Switch back and forth between the FT-101ZD and the FV-101DM by pushing the VFO and EXT buttons to ensure perfect alignment.
4. Now rotate the CALIB control on the FV-101DM so that the corresponding digits of the display on the FT-101ZD match those on the FV-101DM. Remember the FV-101DM has one extra digit of resolution.
5. Once this calibration is completed, normal operation may commence. One rotation of the main tuning knob produces a frequency change of 4 kHz. If the main tuning dial is rotated in one direction for two seconds or more, the frequency change will be speeded up to the rate of 8 kHz per revolution. If the FAST button is pushed while tuning the main dial, these rates become 40 kHz and 80 kHz per revolution, respectively.
6. To engage a ± 5 kHz or ± 20 kHz shift of the operating frequency, press the appropriate keys. These shifts are especially useful during net operation, as instant frequency change may be achieved.
7. To select scanning toward a higher frequency, press the UP button located below the main tuning dial. The initial scanning rate will be 500 Hz/sec., with the scan rate automatically

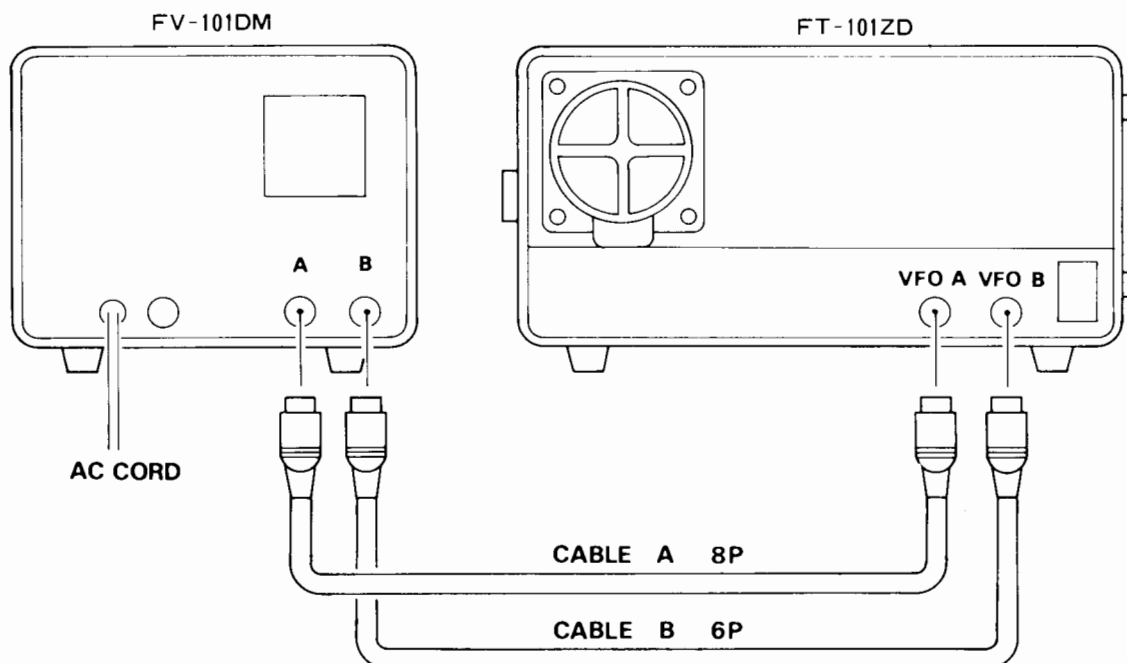

increasing to 1 kHz/sec. after two seconds. In like fashion, pushing the DWN button will cause scanning to commence toward a lower frequency.

8. To increase the scanning rate, push the FAST button. The scanning rate will increase to 5 kHz/second, increasing to 10 kHz/second after two seconds.

MEMORY OPERATION

A frequency that is to be stored in memory can be entered either from the keyboard on the FV-101DM or from the dialed display on the FT-101ZD. A frequency dialed on the FV-101DM can **not** be stored into memory, even though it can be used for operation. Remember that if the M INH LED indicator is on, memory can not be changed.

A. MEMORY PROGRAMMING FROM THE KEYBOARD

1. Preset the controls and switches as follows:
 - a) Set the controls on the FT-101ZD to the desired band and mode (the other controls on the FT-101ZD are not critical for keyboard entries).

Do not try to memorize frequencies outside of the limits of the selected band.
 - b) Set the FV-101DM SELECT switch to MR (or RV-TM or RM-TV) to enable the keyboard functions.
 - c) Set the FV-101DM MEMORY CH selector to the desired channel. If channels 9 through 12 are selected the MW button must be depressed and held for all other keyboard operations.
 - d) Set the FV-101DM CLAR key so that the CLAR LED indicator is off.
 - e) Set the FV-101DM M SHIFT key so that the M SHIFT LED is off.

Notice that the tuning dial on the FV-101DM is now disengaged.
 - f) Set the FV-101DM LDB key so that the 10 Hz (last to the right) digit is either blanked or not, as you desire.

We recommend that you blank the 10 Hz digit while becoming familiar with the operation of the FV-101DM, as the resolution of the display will then match that of the FT-101ZD (except when programming from the

keyboard). Later, you will find the extra digit useful for very precise frequency control.

2. Depressing the KEY button will now cause the 100 kHz (left-most) digit to blink, and depressing the numbered key corresponding to this digit of the new frequency to be stored will cause the new number to appear and the 10 kHz digit to begin to blink. Depressing the numbered key corresponding to the 10 kHz digit of the new frequency will now cause it to appear and the 1 kHz digit to begin to blink, and so forth down to the 10 Hz digit. After the 10 Hz digit is entered the 100 kHz digit will again begin to blink. Depress the ENT key, and the blinking will cease. The new frequency is now stored in the selected memory channel.

It is not necessary to re-enter each digit when a new frequency is to be stored. Merely depress the KEY button to advance the pointer (blinking digit) to the right if you do not wish to change that digit. Depressing the ENT key at any time, regardless of which digit is blinking, will cause the displayed frequency to be entered into the memory channel (if the KEY button has been depressed first).

B. MEMORY PROGRAMMING FROM THE FT-101ZD DIAL

1. Preset the controls and switches as follows:
 - a) Set the FT-101ZD BAND and MODE switches for the desired band and mode.
 - b) Set the FT-101ZD SELECT switches (beneath the main tuning knob) to VFO.
 - c) Set the FV-101DM SELECT switch to MR to link the FV-101DM memory system to the FT-101ZD VFO. (The FV-101DM display need not agree with the frequency displayed on the FV-101ZD)
 - d) Set the FV-101DM MEMORY CH selector to the desired channel. If channels 9 through 12 are selected the MW button will have to be depressed along with the M button (mentioned later).
 - e) Set the FV-101DM CLAR key so that the CLAR LED indicator is off.
 - f) Set the FV-101DM M SHIFT key so that the M SHIFT LED is off.
 - g) Set the FV-101DM LDB key so that the 10 Hz digit is blanked.

2. Tune the Dial of the FT-101ZD to the desired frequency to be memorized.
3. Depress the M button on the FV-101DM (and the MW button at the same time if you are programming channels 9 through 12).
4. When you release the M button the FV-101DM display will change to match the frequency shown on the FT-101ZD. This frequency is now stored in the memory channel.

C. MEMORY RECALL

1. Preset the controls and switches as follows:
 - a) Set the FT-101ZD BAND and MODE selectors to the correct band and mode for the memory to be recalled (i.e.: the same as those for which it was stored).
 - b) Set the FT-101ZD SELECT switches to EXT, (or to TX-EXT or EXT-RX for split frequency operations mentioned later).
 - c) Set the FV-101DM MEMORY CH selector to the desired memory channel.
 - d) Ensure that the CLAR and M SHIFT LED indicators are off.
 - e) Set the FV-101DM SELECT switch to MR (or RV-TM or RM-TV for split operations).
2. You will now see displayed on the both the FT-101ZD and the FV-101DM the frequency stored in the memory channel. Simply rotate the FV-101DM MEMORY CH selector to check any or all channels.

D. MEMORY SHIFT

1. CLARIFIER.
Whenever the FT-101ZD is being operated from a memory channel (FT-101ZD SELECT switches having EXT, TX-EXT or EXT-RX depressed) the CLAR key can be depressed to allow the tuning DIAL of scanner of the FV-101DM to vary the frequency from that of the memory channel selected (the new frequency can be stored by pressing M).
2. $\pm 20, \pm 5$ kHz.
When the CLAR LED indicator is off the $-20, +20, -5, \text{ and } +5$ kHz keys can be used to shift the frequency of the memory channel selected.

3. Depressing the M SHIFT key allows the frequency of the memory channel to be changed either via the main tuning Dial or the scanning controls. Depress this key again to return to the original frequency.

F. TRANSCEIVE OPERATION USING THE FV-101DM

In order to transfer the transceive function from control by the FT-101ZD to the FV-101DM, simply depress the FT-101ZD EXT switch. Now you may choose between frequency control via the tuning Dial on the FV-101DM (set the FV-101DM SELECT switch to D VFO), or control via the memory system and keyboard (set the FV-101DM SELECT switch to MR).

G. SPLIT FREQUENCY OPERATION

Split frequency operation may be performed either by using the FT-101ZD for one function and the FV-101DM for the other, or by using the FV-101DM alone to control both functions.

To use the FT-101ZD for receive and the FV-101DM for transmit, simply depress the FT-101ZD TX-EXT switch and then choose between transmit frequency control via the tuning Dial and scanner or the memory system and keyboard (FV-101DM SELECT switch to D VFO or MR, respectively). The $\pm 20, \text{ and } \pm 5$ buttons may also be used in either case.

To use the FT-101ZD for transmit and the FV-101DM for receive, simply depress the FT-101ZD EXT-RX switch and proceed as above.

In order to control both transmit and receive functions with the FV-101DM alone, depress the FT-101ZD EXT switch. With the FV-101DM it is possible to control one function with the Dial while controlling the other function with the memory system and keyboard. Using the FV-101DM SELECT switch, choose either RV-TM (receive with VFO Dial, transmit with memory or keyboard; or RM-TV (receive with memory or keyboard, transmit with VFO Dial). With the FT-101ZD in the receive mode, only the receive frequency will be shown on the FV-101DM display. However, if you wish to display the transmit

frequency without keying the transmitter, you can simply switch the FV-101DM SELECT switch to the inverse of your selected position, i.e.: – if you are receiving with the VFO Dial and transmitting with the memory system (RV-TM), simply switch to the RM-TV position to see your transmit frequency on the display (remember to switch back to RV-TM again before you transmit). Always set the FV-101DM SELECT switch to either RM-TV or to MR when changing the frequency of the FV-101DM using the MEMORY CH, or numerical keyboard functions. The scan function will operate in SELECT switch positions D VFO or RV-TM; and the ± 20 , ± 5 functions will operate in all positions.

H. PRACTICAL OPERATING EXAMPLES

1. You are operating on 40 meter phone, listening for DX between 7050 and 7100 kHz, while transmitting above 7150 kHz (operators outside the USA should reverse the preceding). Station DX1DX is heard on 7095 kHz, listening at 7205 kHz.

Proceed as follows:

If you are tuning on the FT-101ZD VFO, press the TX-EXT switch beneath the tuning dial on the FT-101ZD. Then set the SELECT switch on the FV-101DM to MR. Also on the FV-101DM, press the KEY button and then 2, 0, 5, 0 and 0. Then press the ENT key and you are ready to transmit.

If you were tuning initially on the FV-101DM VFO, store DX1DX's frequency in memory position 1 by switching the SELECT SW to MR. Key in 0, 9, 5, 0, 0; and press ENT. Now set the SELECT switch to D VFO and tune the FV-101DM main dial to 7205 kHz, and set the SELECT switch to RM-TV. You are now ready to operate. To listen to the pile-up calling DX1DX on 7205 kHz, just set the FV-101DM SELECT switch to RV-TM. Should DX1DX begin to drift in frequency, the clarifier may be activated to follow the unstable signal.

2. You are net control station for a net meeting on 14315 kHz. Stations call into the net, then are moved off frequency. Prior to the start of the net, store typical QSY frequencies (14280, 14285, 14290, 14295, etc.) in the FV-101DM memory bank. The net control station may

then quickly determine whether or not a particular frequency is clear by keeping the FV-101DM SELECT switch in the MR position and just setting the MEMORY CH selector appropriately (the FT-101ZD EXT switch must be depressed).

3. You are operating in a DX contest (tuning with the FT-101ZD VFO), where a number of desired stations are on the band at the same time. If some of them do not respond immediately to your call, or if they are not acknowledging your call area, store them in the FV-101DM memory bank by simply pressing M with the SELECT switch in the MR position and the MEMORY CH selector in the desired position. Then by just rotating the MEMORY CH selector the various stations may be checked quickly. Your total exposure on the band is, thus, increased. Note that, even though a band change is made in the meantime, the memorized frequencies remain valid upon return to the band on which they were stored!

I. FV-101DM MEMORY BACK-UP

The memories stored in the FV-101DM may be retained when the line voltage supply is interrupted (during power outages or transport of the equipment) simply by installing two AA size batteries. Remove the small access panel on the rear of the FV-101DM by disengaging the latch pin, and install the batteries as illustrated, paying special attention to polarity. Although the memory back-up current is a mere $10 \mu\text{A}$, we recommend that the batteries be replaced every six months to avoid leakage and possible damage to the FV-101DM.

NOTE:

In certain circumstances, after installation of the back-up batteries, the memory functions of the FV-101DM may not function. This can be easily remedied by the following steps:

1. Switch the power to the FT-101ZD OFF, and remove the wall plug of the FV-101DM from the wall outlet.
2. Remove the backup batteries from the holder on the FV-101DM.
3. Wait at least 30 seconds.
4. Switch the power to the FT-101ZD back ON.
5. Replace the batteries into their holder, and plug the FV-101DM back into the wall outlet.

FV-101DM SELECT SWITCH POS FT-101ZD SELECT SWITCH	D VFO	MR	RV-1M	RM-1V
VFO	TX: XCVR VFO RX: XCVR VFO	(SAME)	(SAME)	(SAME)
EXT	TX: DM VFO (KEYBOARD) RX: DM VFO (KEYBOARD)	TX: MEMORY (KEYBOARD) RX: MEMORY (KEYBOARD)	TX: MEMORY* (KEYBOARD) RX: DM VFO (KEYBOARD)	TX: DM VFO* (KEYBOARD) RX: MEMORY (KEYBOARD)
TX EXT	TX: DM VFO* (KEYBOARD) RX: XCVR VFO	TX: MEMORY* (KEYBOARD) RX: XCVR VFO	TX: MEMORY* (KEYBOARD) RX: XCVR VFO	TX: DM VFO* (KEYBOARD) RX: XCVR VFO
RX EXT	TX: XCVR VFO* RX: DM VFO (KEYBOARD)	TX: XCVR VFO* RX: MEMORY (KEYBOARD)	TX: XCVR VFO* RX: DM VFO (KEYBOARD)	TX: XCVR VFO* RX: MEMORY (KEYBOARD)

NOTE: XCVR VFO = FT-101ZD INTERNAL VFO, DM VFO = FV-101DM's VFO.

* Split frequency operation.

Table 1

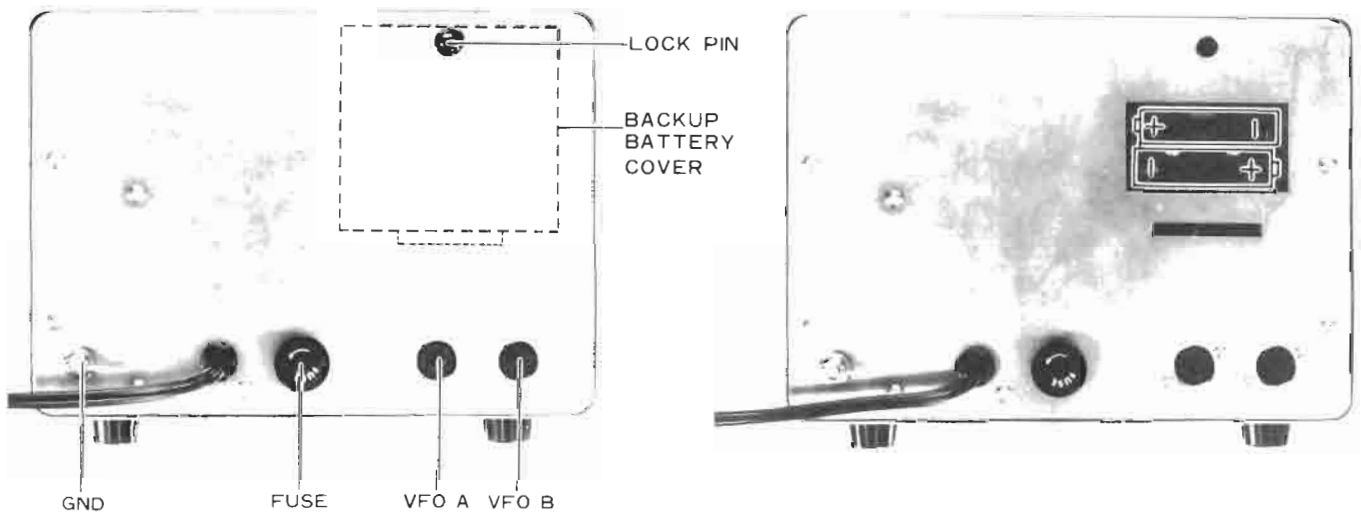

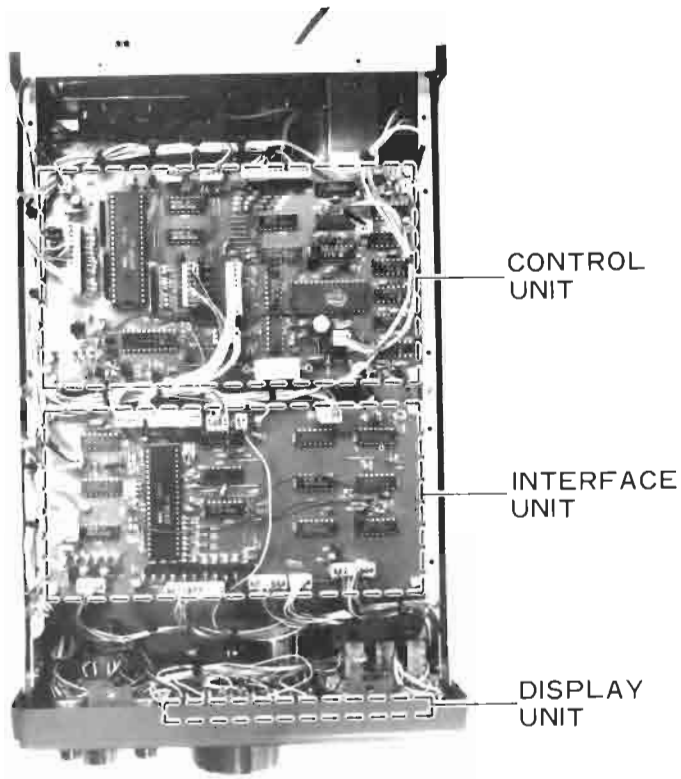

TOP VIEW

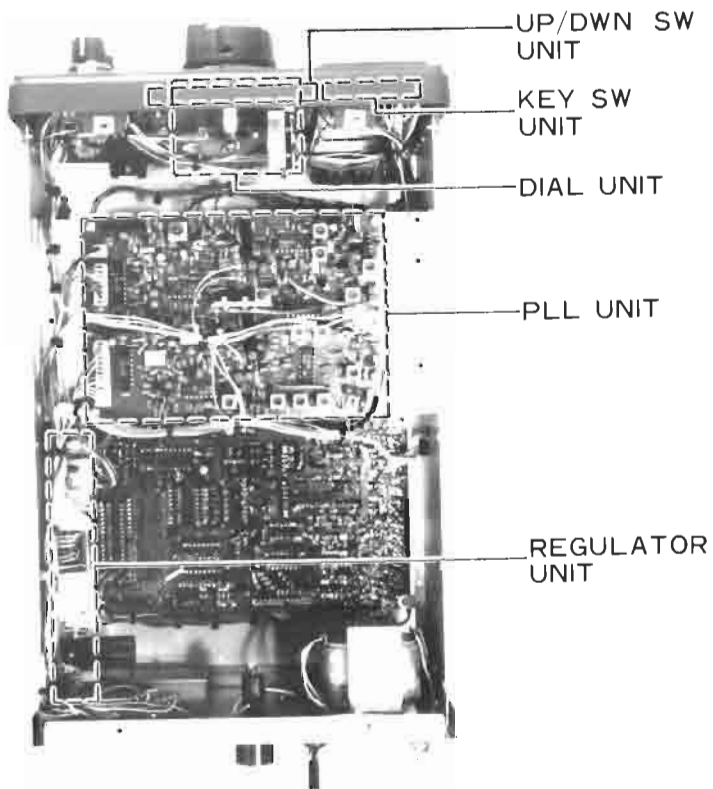

BOTTOM VIEW

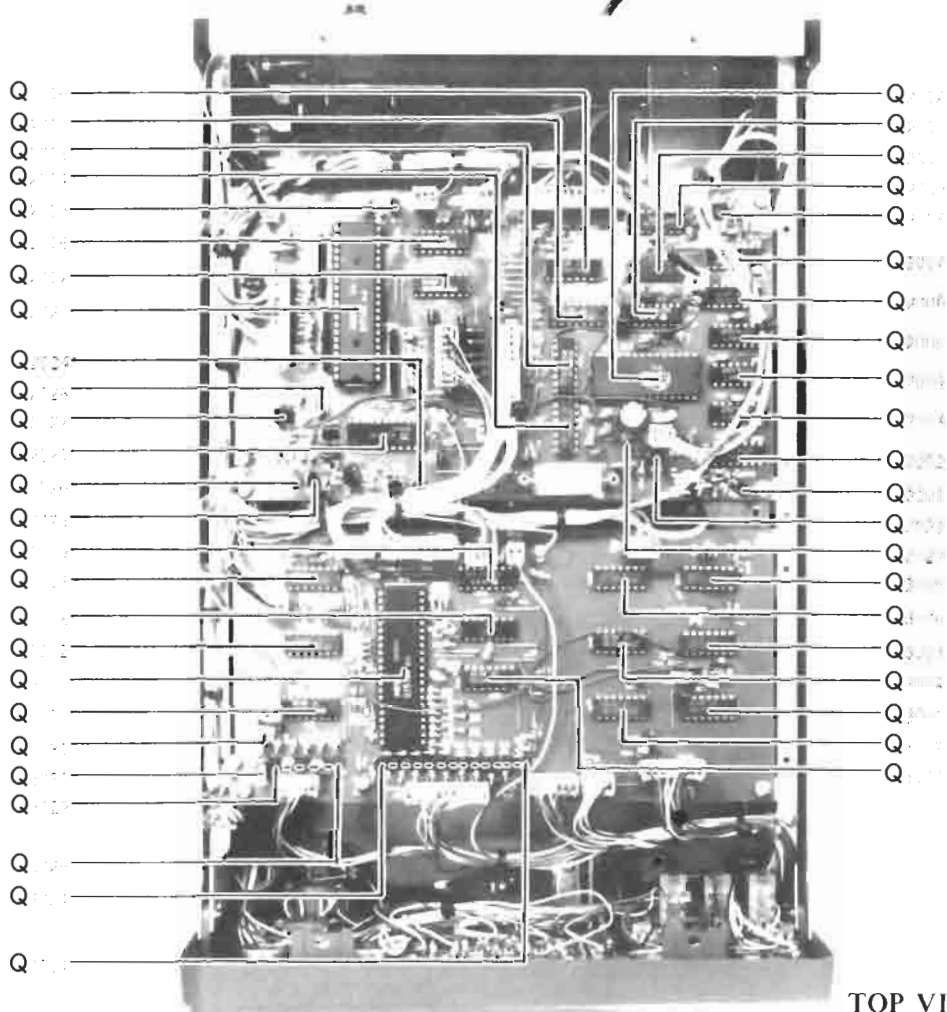

TOP VIEW

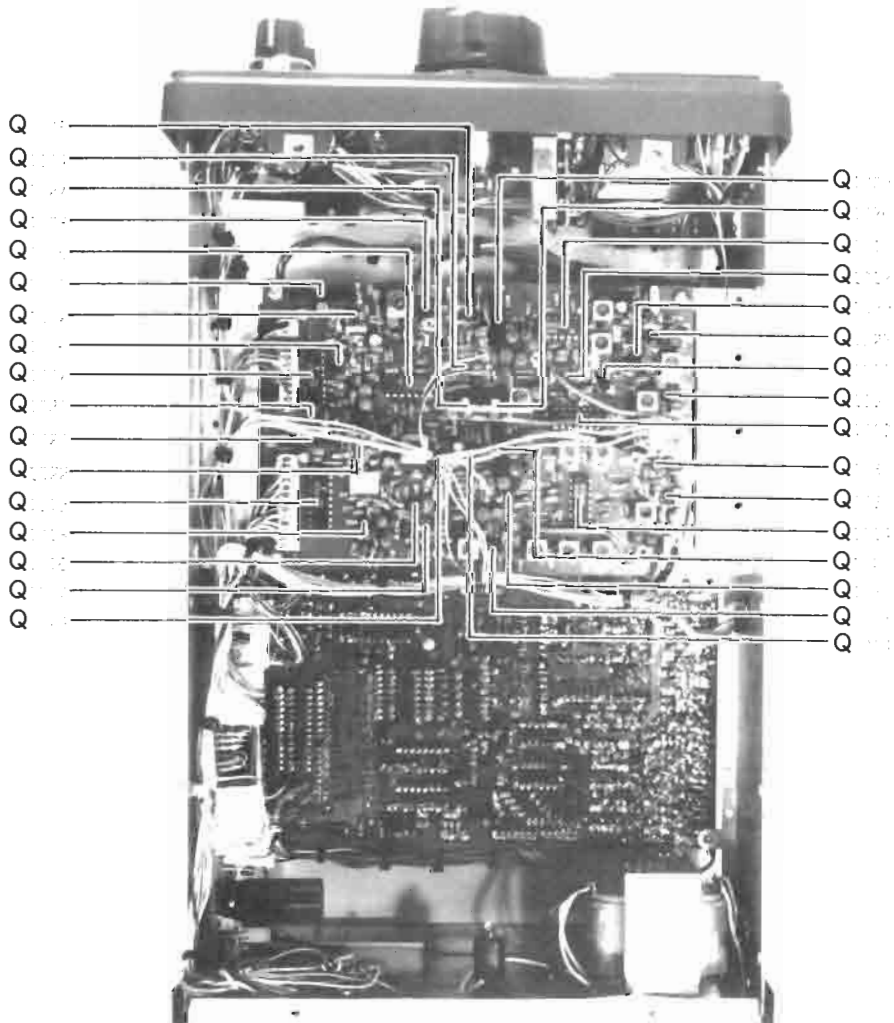

BOTTOM VIEW

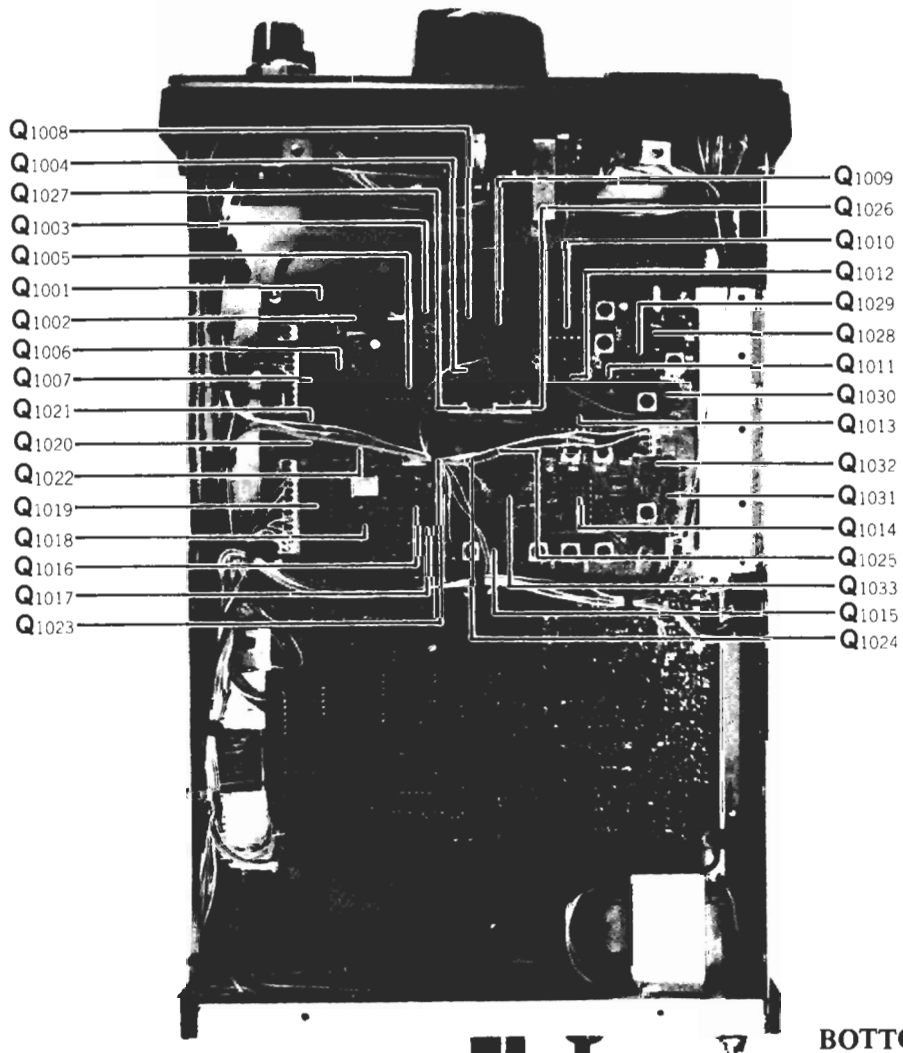
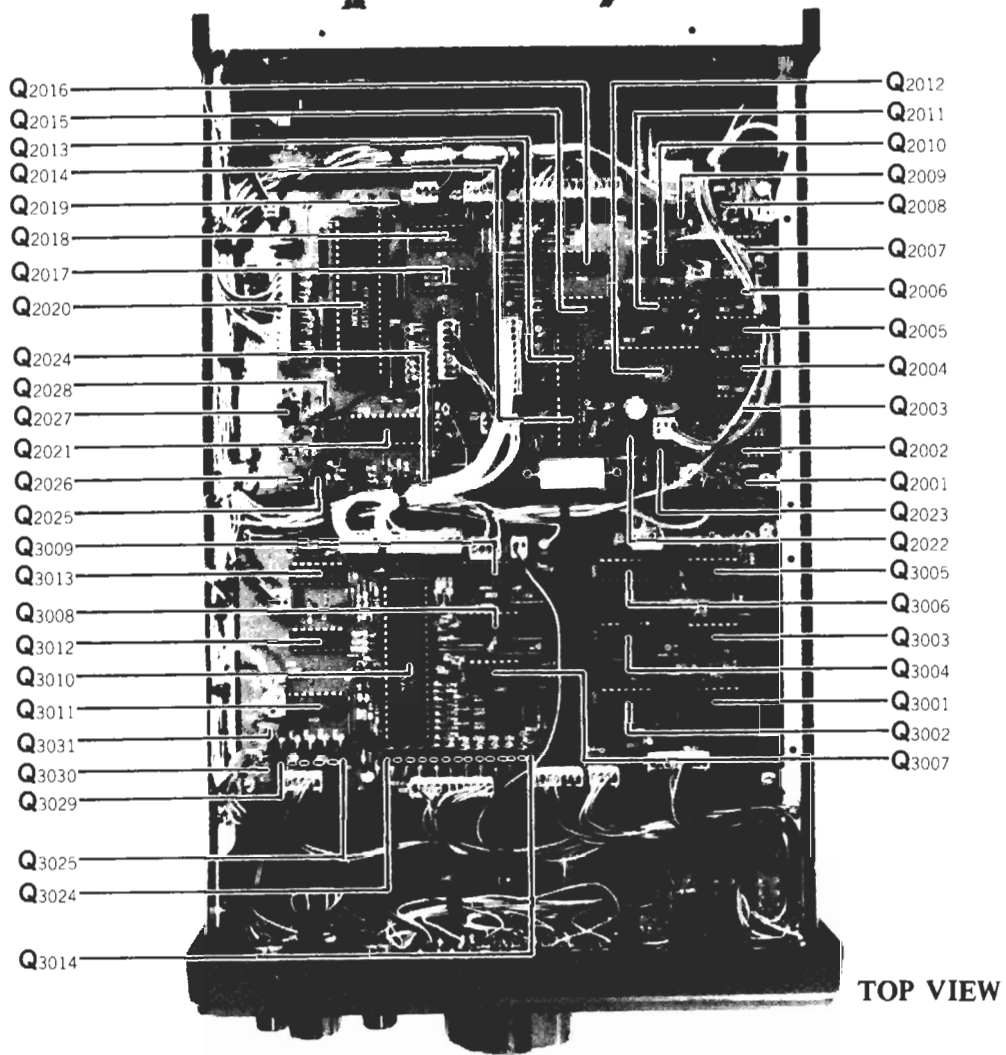

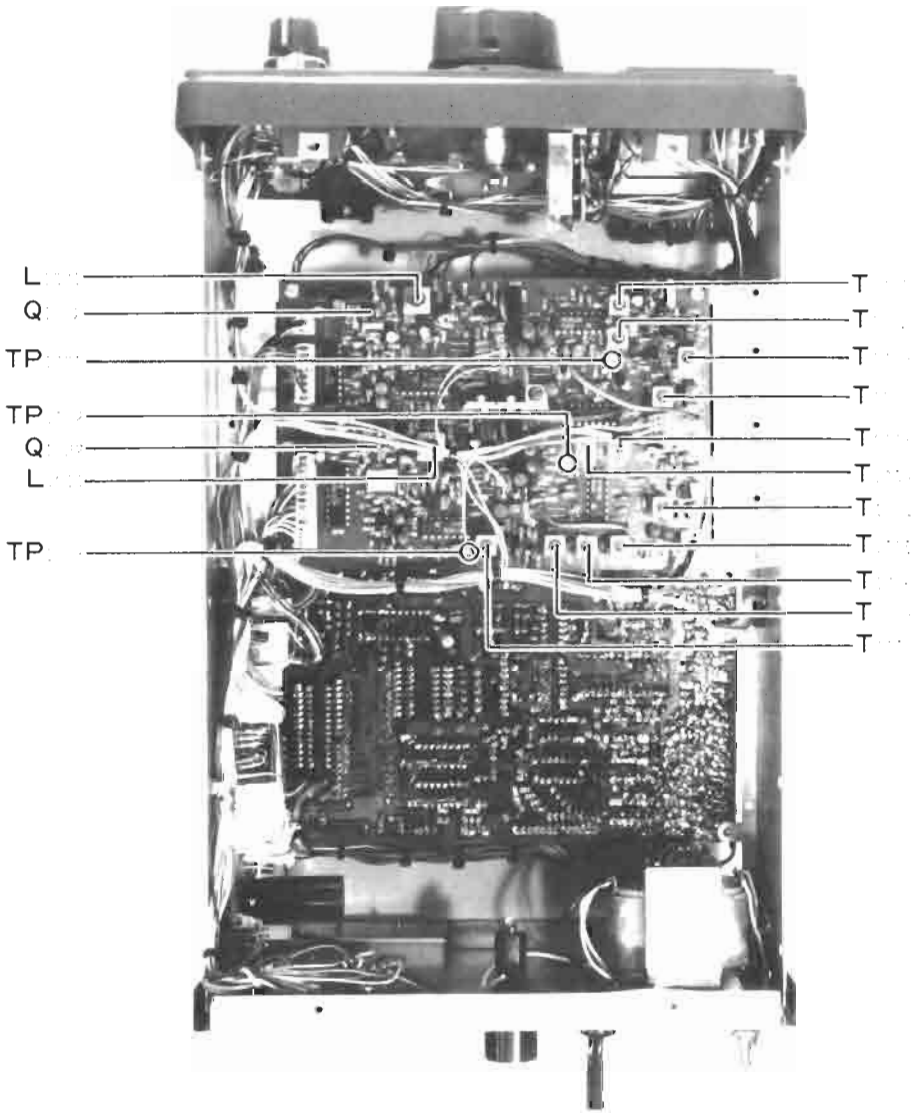
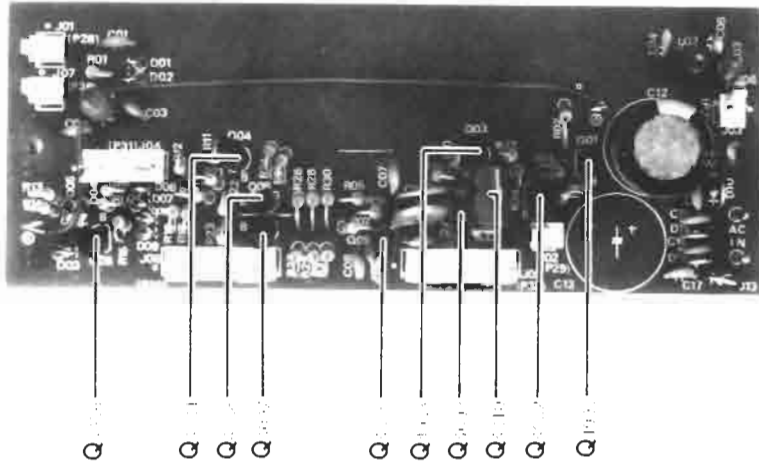

MEMO

PARTS LIST

MAIN CHASSIS			P3,14 (with wire)	T9204258	5102-02
Symbol No.	Part No.	Description	P4,36 (")	T9204259	5102-02
		TRANSISTOR	P5 (")	T9204260A	5102-05
Q1,2	G3208560B	2SB856B	P6,24 (")	T9204261	5102-10
	Q9000109	Insulator SK16B	P7,25 (")	T9204262	5102-05
			P8 (")	T9204263	5102-13
			P9,19 (")	T9204264	5102-04
		RESISTOR	P10 (")	T9204265	5102-03
R2	J01245821	Carbon film 1/4W TJ 820Ω	P13 (")	T9204266	5102-02
R3	J01245472	" " " " 4.7kΩ	P15 (")	T9204267	5102-02
R1	J01245103	" " " " 10kΩ	P16,27 (")	T9204268	5102-02
			P17 (")	T9204269	5102-03
			P18 (")	T9204270	5102-08
		POTENTIOMETER	P20 (")	T9204271	5102-11
VR1,2	J60800077	K161100AZE 5KB 5kΩB	P21 (")	T9204272	5102-05
			P22 (")	T9204273	5102-07
			P23 (")	T9204274	5102-03
		CAPACITOR	P26 (")	T9204275	5102-04
C1-9	K13170103	Ceramic disc 50WV 0.01μF (DD201YF103Z5L5)	P28 (")	T9204276	5102-02
			P29 (")	T9204277	5102-02
			P30 (")	T9204278	5102-02
			P31 (")	T9204279	5102-06
		POWER TRANSFORMER	P32 (")	T9204280	5102-08
PT1	L3030089		P33 (")	T9204281	5102-08
			P34 (")	T9204282	5102-04
			P35 (")	T9204283	5102-02
		SWITCH			
S1	N0190041	SRN202CN			
S2 (with S3, S4)	N4090044	SUF-32 (SUF-S-001 Non lock)			POWER CORD
S3	-	(SUF-S-001 Self lock)		T9000180	2 wire, 2 prong plug
S4	-	(SUF-S-001 Self lock)		S0000024	Cord bushing F-4
S5	N0190032	SRN1034N-E3			
S6	N4090045	SUF-12		T9000482	3 wire, 3 prong UL plug
				S0000022	Cord bushing R-5
		DIN JACK		T9000680	3 wire, 3 prong Australian plug
J1	P1090246	D8-701B-00		S0000022	Cord bushing R-5
J2	P1090033	D6-701B-00			
				T9000684	3 wire, 2 prong EU plug
				S0000022	Cord bushing R-5
		FUSE HOLDER			
FH1	P2000012	SN-2059			
					KNOB
				R3040670B	Main tuning
		FUSE		R3040921A	Ring knob
F1	Q0000002	1A (100V-117V AC)		R3068460	Select, M channel FT-24PNA
	Q0000001	0.5A (200V-234V AC)		R3068620	Dimmer, Calibrate FT-16PK
				R3056500	Push knob MW, M, D lock, B off
				R3057110	Keyboard push knob 0
		BATTERY HOLDER		R3057111	" " " 1
	P2000013	C3		R3057112	" " " 2
P37	P2000021	Battery snap		R3057113	" " " 3
				R3057114	" " " 4
				R3057115	" " " 5
		LAMP HOLDER		R3057116	" " " 6
PLH1	P2000003	F-3265		R3057117	" " " 7
				R3057118	" " " 8
				R3057119	" " " 9
		PILOT LAMP		R3070680	" " " ENT
PL1	Q1000039	BF311-04071		R3070681	" " " ▶
		MINI CONNECTOR			
P1,11 (with wire)	T9204256	5102-13			
P2,12 (")	T9204257	5102-08			

PLL UNIT			R1066,1070,1074, 1081,1093	J02245103	Carbon film 1/4W SJ 10kΩ
Symbol No.	Part No.	Description			
PB-2299A	F0002299A	Printed circuit board	R1090	J02245153	" " " " 15kΩ
	C0229900	PCB with components	R1065	J02245223	" " " " 22kΩ
			R1006,1016,1034, 1045,1069	J02245333	" " " " 33kΩ
		IC	R1073,1080	J02245563	" " " " 56kΩ
Q1009,1025	G1090296	HD10551	R1005,1010,1026, 1028,1038,1058, 1059,1062,1077, 1078,1084	J02245104	" " " " 100kΩ
Q1005,1010,1014, 1017	G1090062	SN76514N			
Q1013	G1090034	SN74LS90N			
Q1001,1020	G1090048	TC5081P			
Q1007,1019	G1090247	TC9122P			
Q1026	G1090299	μPC7805H			
Q1027	G1090294	μPC7808H	TH1001	G9090008	THERMISTOR 31D26
		FET			CAPACITOR
Q1016,1023	G3090035	2SK19TM-GR	C1099	K00172010	Ceramic disc 50WV SL 1pF (DD104SL010C50V02)
			C1011,1030,1060, 1098	K00172020	" " " " 2pF (DD104SL020C50V02)
		TRANSISTOR	C1052,1109	K00172050	" " " " 5pF (DD104SL050C50V02)
Q1003,1004,1006, 1008,1015,1018, 1024,1030,1031, 1033	G3305350A	2SC535A	C1045	K00173060	" " " " 6pF (DD104SL060D50V02)
Q1011,1012,1021, 1028,1029,1032	G3318150Y	2SC1815Y	C1004,1008,1093	K02173060	" " " " CH6pF (DD104CH060D50V02)
Q1002,1022	G3090005	MPS-A13	C1005	K06173090	" " " " UJ 9pF (ECC-D1H060DU)
			C1006	K02173100	" " " " CH10pF (DD104CH100D50V02)
		DIODE	C1061,1118	K00173100	" " " " SL 10pF (DD104SL100D50V02)
D1001	G2022090	Varactor 1S2209	C1020,1022,1074, 1076	K00175150	" " " " 15pF (DD104SL150J50V02)
D1002,1003	G2090043	" MV104	C1035,1038,1051, 1121	K00179005	" " " " 20pF (DD104SL200J50V02)
			C1092	K02179011	" " " " CH27pF (DD105CH300J50V02)
		CRYSTAL	C1009,1094	K02179013	" " " " 33pF (DD105CH330J50V02)
X1001	H0102418	HC-18/U 30MHz	C1021,1034,1075, 1113,1124	K00175330	" " " " SL 33pF (DD104SL330J50V02)
			C1036,1037	K00175390	" " " " 39pF (DD104SL390J50V02)
		RESISTOR	C1125,1128,1129	K02175470	" " " " 47pF (DD106CH470J50V02)
R1008,1011,1013, 1015,1018,1022, 1025,1030,1033, 1037,1039,1041, 1043,1046,1060, 1063,1067,1072, 1075,1076,1082, 1083,1085,1086, 1091,1092,1095, 1096	J02245101	Carbon film 1/4W SJ 100Ω	C1090	K02175680	" " " " CH68pF (DD107CH680J50V02)
R1004,1053	J02245151	" " " " 150Ω	C1107	K02175820	" " " " 82pF (DD107CH820J50V02)
R1012,1020,1023, 1036,1040,1048, 1061,1064,1071	J02245331	" " " " 330Ω	C1025,1079,1126, 1127	K00175101	" " " " SL 100pF (DD105SL101J50V02)
R1009,1014,1024, 1042,1050,1068, 1079,1087,1088, 1094	J02245561	" " " " 560Ω	C1106	K02175121	" " " " CH120pF (DD109CH121J50V02)
R1052	J02245821	" " " " 820Ω	C1003,1010, 1012-1119,1023, 1024,1026-1028, 1031,1032, 1039-1044, 1046-1050, 1053-1059, 1062-1064, 1066-1073,1077, 1078,1080-1082, 1086,1089,1096	K13170103	" " " " 0.01μF (DB201YF103Z5L5)
R1001-1003,1019, 1027,1029,1047	J02245102	" " " " 1kΩ			
R1031	J02245222	" " " " 2.2kΩ			
R1089	J02245332	" " " " 3.3kΩ			
R1051,1054-1057	J02245472	" " " " 4.7kΩ			
R1007,1017,1032, 1035,1044,1049	J02245103	" " " " 10kΩ			

C1097,1100,1101,1103,1108,1110-1112,1114-1116,1119,1120,1122,1123,1130,1131,1135,1136	K13170103	Ceramic disc 50WV 0.01μF (DB201YF103Z5L5)	Q2015	G1090179	MC14001B
			Q2014	G1090068	MC14011B
			Q2013	G1090332	MC14194B
			Q2006,2007	G1090108	MC14518B
			Q2017,2018	G1090050	MC14519B
C1033,1102,1104,1105	K13170473	" " " 0.047μF (DB207YF473Z5L5)	Q2010	G1090156	MM74C00N
			Q2009	G1090135	MSM4011
C1088	K50177333	Mylar " 0.033μF (50F2U333M)	Q2002-2005	G1090034	SN74LS90N
			Q2011	G1090100	SN74LS123N
C1001,1007,1029,1083,1084,1087,1095,1117,1137	K40129004	Electrolytic 16WV 10μF (16RE10)	Q2012	G1090098	TC5032P
			Q2022	G1090084	78L05
			Q2020	G1090331	μPD1510C-13
C1002	K54200003	Polyethylene film 100WV 0.1μF (B32560-A1104J)	Q2021	G1090227	μPD5101LC
C1085	K54200001	" " " 1μF (B56321-A1105J)			
					FET
			Q2008	G4800730G	3SK73GR
INDUCTOR					
L1001	L0021080				TRANSISTOR
L1011	L0021081		Q2023,2024,2027,2028	G3107331Q	2SA733AQ
L1014	L1020034				
L1012	L1190004	FL4H-R68M	Q2001	G3305350B	2SC535B
L1019,1020	L1190007	FL4H-1R8M	Q2019,2025,2026	G3318150Y	2SC1815Y
L1009,1010	L1190070	FL4H-8R2M			
L1002,1003	L1190015	FL5H-120K			
L1005-1007	L1190019	FL5H-150K			DIODE
L1015-1017	L1190023	FL5H-220K	D2001-2014,2016	G2015550	Si 1S1555
L1004,1008,1013,1018	L1190020	FL5H-151K	D2015	G2090001	" 10D1
TRANSFORMER					RESISTOR
			R2056	J30376339	Cement 5W 3.3Ω (RW5P 3.3Ω)
T1001	L0020806				
T1002	L0020801		R2057	J20306059	Metallic film 1W 0.5Ω (RS1B 0.5Ω)
T1003,1004	L0020802				
T1005	L0020807		R2001,2002,2007,2011	J02245101	Carbon film 1/4W SJ 100Ω
T1006-1008,1011	L0020805				
T1009	L0020804		R2059	J02245151	" " " " 150Ω
T1010	L0020803		R2058	J02245221	" " " " 220Ω
			R2061	J02245471	" " " " 470Ω
			R2013,2016,2028	J02245561	" " " " 560Ω
		MINI CONNECTOR	R2005	J02245681	" " " " 680Ω
J1001	P0090229	5045-13A	R2010,2066	J02245102	" " " " 1kΩ
J1002	P0090224	5045-08A	R2019,2024,2030-2049	J02245472	" " " " 4.7kΩ
J1003,1004	P0090218	5045-02A			
J1005	P0090221	5045-05A	R2004,2006,2018,2025,2027,2062	J02245103	" " " " 10kΩ
			R2003,2014,2015	J02245333	" " " " 33kΩ
		TERMINAL	R2008,2009,2017,2020-2023,2026,2050-2053,2060,2070,2074,2075	J02245104	" " " " 100kΩ
	Q5000036	TP-G			
	R0071930	HEAT SINK			
			R2065,2069,2073	J02245684	" " " " 680kΩ
			R2063,2067,2071	J02245105	" " " " 1MΩ
			R2012	J02245155	" " " " 1.5MΩ
			R2054,2055,2064,2068,2072	J02245185	" " " " 1.8MΩ
CONTROL UNIT					
Symbol No.	Part No.	Description			BLOCK RESISTOR
PB-2250A	F0002250A	Printed circuit board			
	C0225000	PCB with components	RB2001	J40900019	RK1/16 100kΩ-8A
			RB2002-2004	J40900021	RA1/8 3.3kΩ-8A

		CAPACITOR			DIODE	
C2010	K00179007	Ceramic disc 50WV SL 30pF (DD104SL300J50V02)	D3001-3012	G2015550	Si	1S1555
C2016	K00175181	" " " " 180pF (DD104SL181J50V02)				
C2001-2009,2015, 2034,2036-2040	K13170103	" " " " 0.01μF (DB201YF103Z5L5)	CO3001	H7900080	CERAMIC RESONATOR	
C2029,2030,2041	K13170473	" " " " 0.047μF (DB207YF473Z5L5)			CSA2.56M	
					RESISTOR	
C2012,2013	K50177102	Mylar 50WV 0.001μF (50F2U102M)	R3072-3079	J02245330	Carbon film	1/4W SJ 33Ω
			R3069	J02245560	" "	" " 56Ω
C2011,2014	K50177222	" " " " 0.0022μF (50F2U222M)	R3067,3068	J02245331	" "	" " 330Ω
			R3029,3062-3066	J02245471	" "	" " 470Ω
C2032,2033	K50177103	" " " " 0.01μF (50F2U103M)	R3028,3071	J02245561	" "	" " 560Ω
			R3070	J02245821	" "	" " 820Ω
C2017-2028	K50177223	" " " " 0.022μF (50F2U223M)	R3030	J02245102	" "	" " 1kΩ
			R3080,3081	J02245152	" "	" " 1.5kΩ
C2042	K40120106	Electrolytic 16WV 10μF (16RL10)	R3041-3047	J02245222	" "	" " 2.2kΩ
			R3019-3021	J02245332	" "	" " 3.3kΩ
C2035	K40080227	" " 6.3V 220μF (6.3RL220)	R3018	J01245332	" "	" TJ 3.3kΩ
			R3009,3012	J02245472	" "	" SJ 4.7kΩ
			R3006,3008, 3031-3036,3040, 3050-3057,3059, 3061	J02245103	" "	" " 10kΩ
		MINI CONNECTOR				
J2001	P0090226	5045-10A				
J2002	P0090221	5045-05A	R3049,3058,3060	J01245103	" "	" TJ 10kΩ
J2003,2006	P0090229	5045-13A	R3023,3024,3026, 3037,3038	J01245104	" "	" " 100kΩ
J2004	P0090220	5045-04A				
J2005,2012	P0090219	5045-03A	R3001-3005,3007, 3013-3017,3022, 3025,3048	J02245104	" "	" SJ 100kΩ
J2007	P0090224	5045-08A				
J2008-2011	P0090218	5045-02A				
			R3039	J02245105	" "	" " 1MΩ
			R3011,3027	J02245185	" "	" " 1.8MΩ
		TERMINAL	R3010	J02245225	" "	" " 2.2MΩ
	P1090178	TP-G				
						CAPACITOR
			C3014-3017	K00175470	Ceramic disc	50WV SL 47pF (DD104SL470J50V02)
					" "	" " 0.01μF (DB201YF103Z5L5)
			C3002,3003,3006, 3008,3010,3011, 3013			
INTERFACE UNIT						
Symbol No.	Part No.	Description				
PB-2249A	F0002249A	Printed circuit board	C3004,3012	K50177102	Mylar	50WV 0.001μF (50F2U102M)
	C0224900	PCB with components				
			C3005	K50177472	" "	" " 0.0047μF (50F2U472M)
		IC	C3009	K70127225	Tantalum	16WV 2.2μF (CS15E1C2R2M)
Q3012	G1090027	MC14001B				
Q3003,3005,3006, 3013	G1090068	MC14011B	C3001,3007	K40100336	Electrolytic	10WV 33μF (10RL33)
Q3004	G1090067	MC14013B				
Q3007	G1090124	MC14016B				
Q3011	G1090051	MC14042B				
Q3002	G1090357	MC14077B	J3001	P0090224	MINI CONNECTOR	
Q3001	G1090290	MC14093B	J3002,3009,3013	P0090220	5045-08A	
Q3008	G1090092	SN74LS00N	J3003	P0090227	5045-04A	
Q3009	G1090100	SN74LS123N	J3004,3008	P0090221	5045-11A	
Q3010	G1090358	μPD1510C-22	J3005	P0090223	5045-05A	
			J3006	P0090219	5045-07A	
			J3007	P0090226	5045-03A	
		TRANSISTOR	J3010,3012	P0090218	5045-10A	
Q3030,3031	G31049600	2SA496-O				
Q3015-3024	G3107331Q	2SA733AQ		P1090178	TERMINAL	
Q3014	G3318150Y	2SC1815Y			TP-G	
Q3025-3029	G3319590Y	2SC1959Y				

REG UNIT				KEY SWITCH UNIT		
Symbol No.	Part No.	Description		Symbol No.	Part No.	Description
PB-2277	F0002277	Printed circuit board		PB-2280	F0002280	Printed circuit board
	C0227700	PCB with components			C0228000	PCB with components
				S5001	N7090001	AKC-8N
		IC				
Q4009	G1090162	78L12				
		TRANSISTOR				
Q4002,4004,4006	G3107331Q	2SA733AQ		DISPLAY UNIT		
Q4010	G3208560B	2SB856B		Symbol No.	Part No.	Description
Q4001,4003,4005,4007,4008	G3318150G	2SC1815GR		PB-2278	F0002278	Printed circuit board
					C0227800	PCB with components
		DIODE				LED
D4001-4009	G2015550	Si	1S1555	D6001-6005	G2090069	5082-7623
D4010-4013	G2090001	"	10D1	D6006-6017	G2090142	TLR226
		RESISTOR				BUZZER
R4005,4008,4032	J02245101	Carbon film	1/4W SJ 100Ω	BZ6001	M4290001	EFBRE-25D02
R4018,4019,4033	J02245471	" "	" " 470Ω			
R4001	J02245102	" "	" " 1kΩ			
R4016,4017	J02245122	" "	" " 1.2kΩ			RESISTOR
R4003,4024,4025	J02245222	" "	" " 2.2kΩ	R6002	J02245471	Carbon film 1/4W SJ 470Ω
R4002,4004,4020-4023,4027,4029,4031	J02245472	" "	" " 4.7kΩ	R6001	J02245152	" " " " 1.5kΩ
R4026,4028,4030	J02245682	" "	" " 6.8kΩ			
R4009-4014,4034	J02245103	" "	" " 10kΩ			
R4007	J02245153	" "	" " 15kΩ			
R4006	J02245333	" "	" " 33kΩ			
R4015	J02245104	" "	" " 100kΩ	UP/DOWN SWITCH UNIT		
				Symbol No.	Part No.	Description
				PB-2279	F0002279	Printed circuit board
					C0227900	PCB with components
		CAPACITOR		S8001-8003	N7090001	AKC-8N
C4004,4006	K10179011	Ceramic disc	50WV 470pF (2222-660-02471)			
C4005	K10179001	" "	" " 1000pF (2222-660-02102)			
C4001-4003,4007-4009,4014-4017	K13170103	" "	" " 0.01μF (DB201YF103Z5L5)			
C4010,4011	K13170473	" "	" " 0.047μF (DB207YF473Z5L5)			
C4012	K40149006	Electrolytic	25WV 2200μF			
		INDUCTOR				
L4002,4003	L1190007	FL4H 1R8M				
L4001	L1190020	FL5H 151K				
						PHOTO SENSOR
				PS401 (PS402)	Q9000124	EE-SH3-X-1
		MINI CONNECTOR				
J4001-4003,4007	P0090218	5045-02A				
J4004	P0090222	5045-06A				RESISTOR
J4005,4006	P0090224	5045-08A		R401 (R403)	J02245221	Carbon film 1/4W SJ 220Ω
	Q50000011	Wrapping terminal C		R402 (R404)	J02245472	" " " " 4.7kΩ
	R6052651	Spacer	ℓ = 8mm			

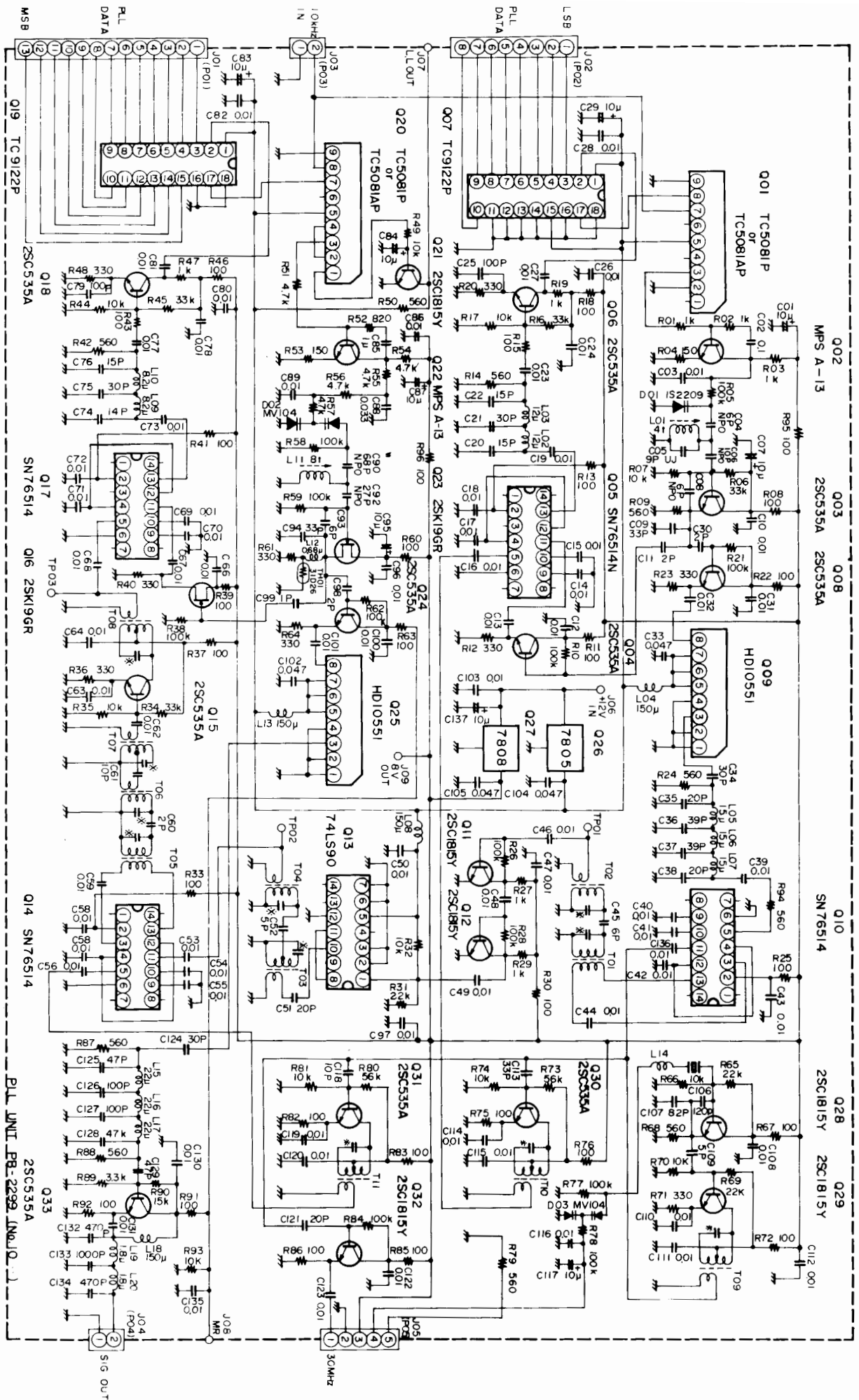

MSB
DATA
PLL
LSB
J02
J03
J07
J08
J09
J10
J11
J12
J13
J14
J15
J16
J17
J18
J19
J20
J21
J22
J23
J24
J25
J26
J27
J28
J29
J30
J31
J32
J33
J34
J35
J36
J37
J38
J39
J40
J41
J42
J43
J44
J45
J46
J47
J48
J49
J50
J51
J52
J53
J54
J55
J56
J57
J58
J59
J60
J61
J62
J63
J64
J65
J66
J67
J68
J69
J70
J71
J72
J73
J74
J75
J76
J77
J78
J79
J80
J81
J82
J83
J84
J85
J86
J87
J88
J89
J90
J91
J92
J93
J94
J95
J96
J97
J98
J99
J100

002
003
008
009
010
028
029
030
031
032
033

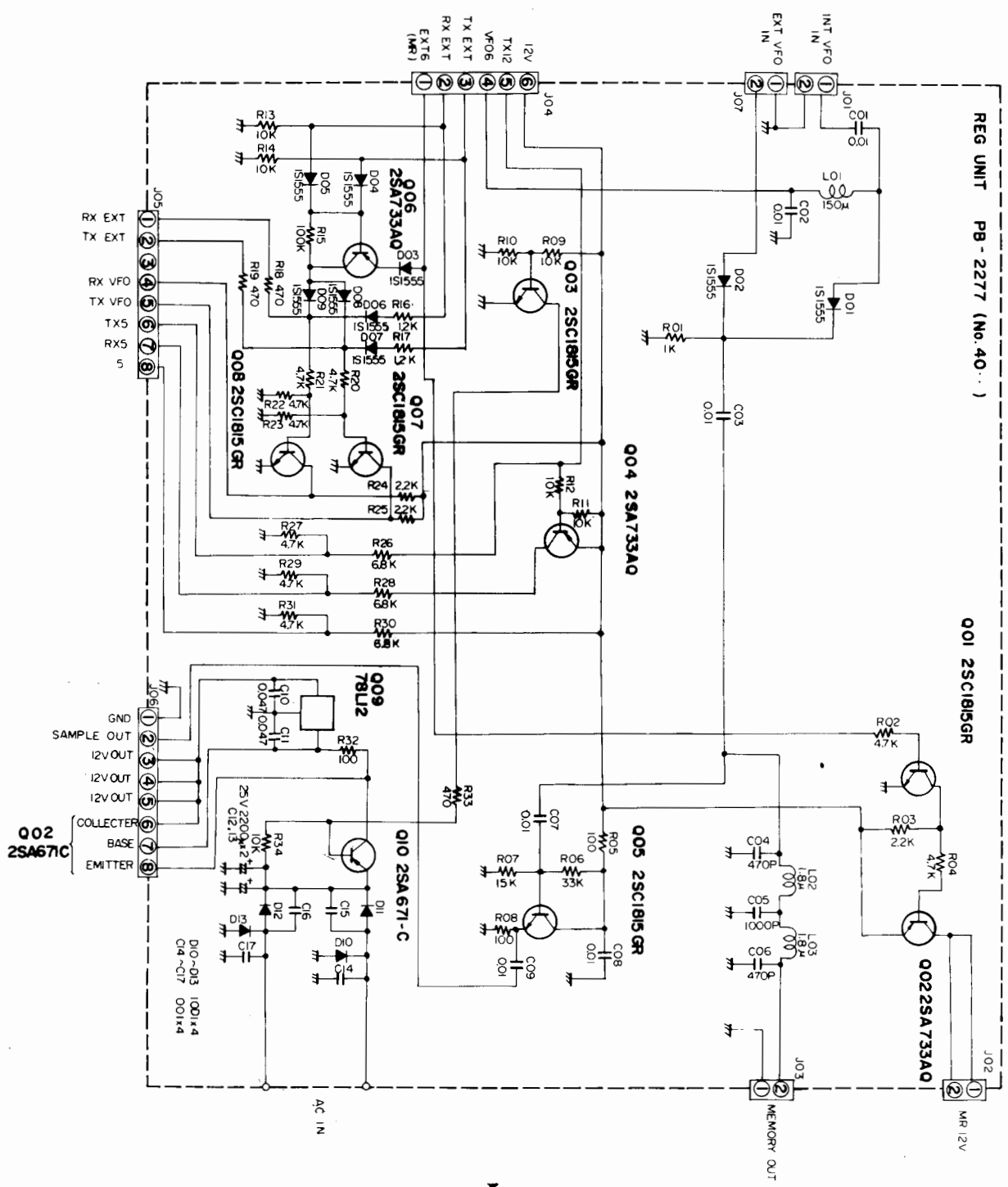

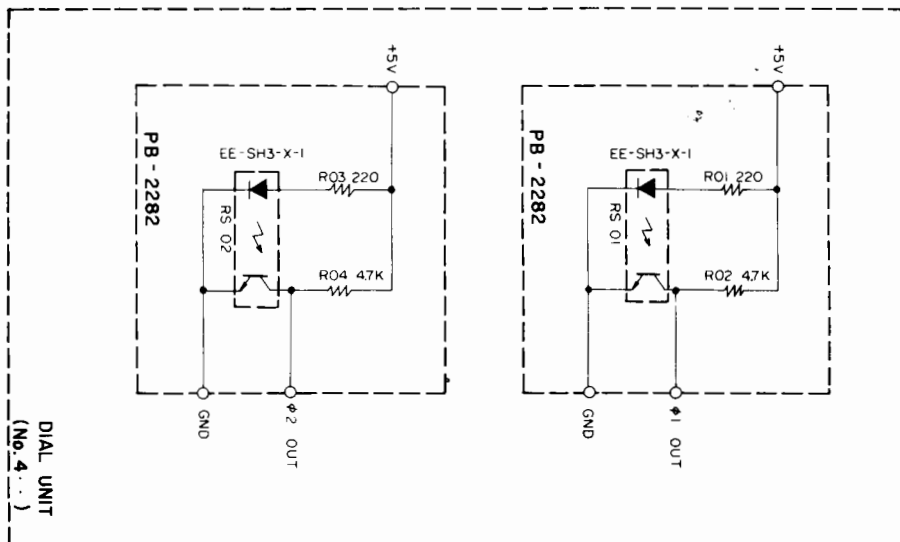
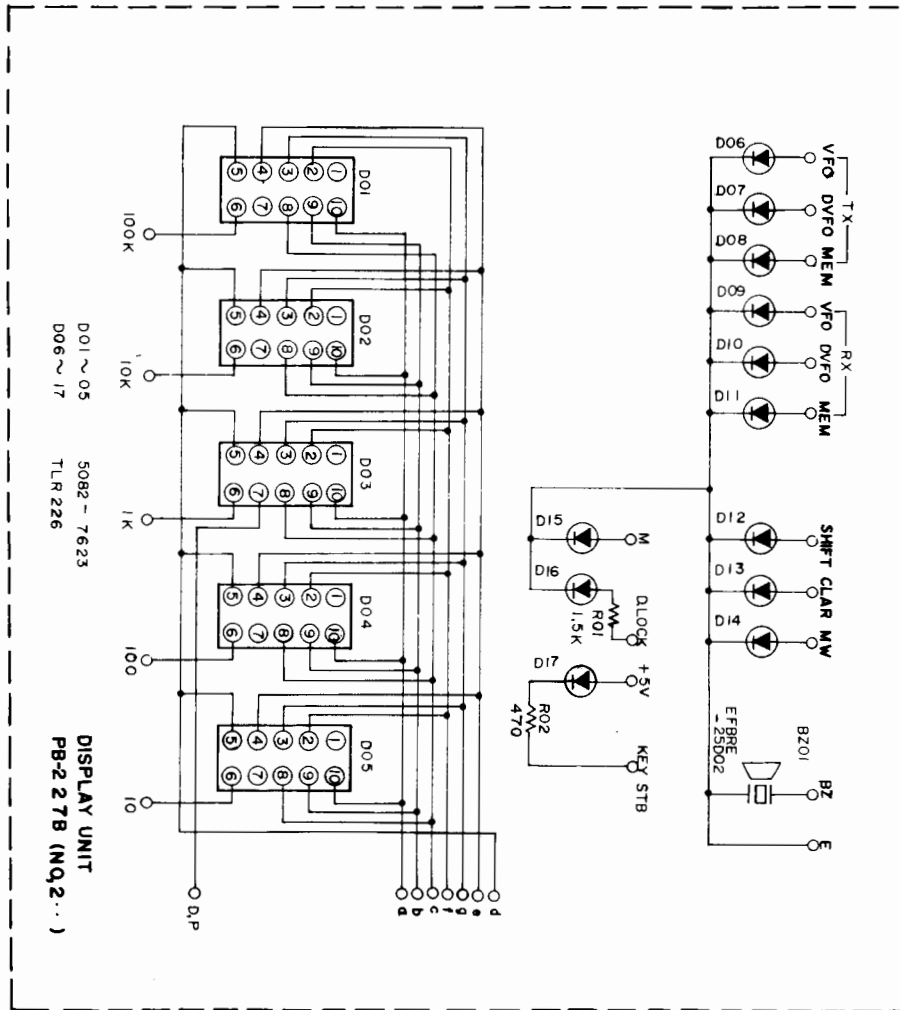

FV-101DM
CIRCUIT DIAGRAM

